

34398

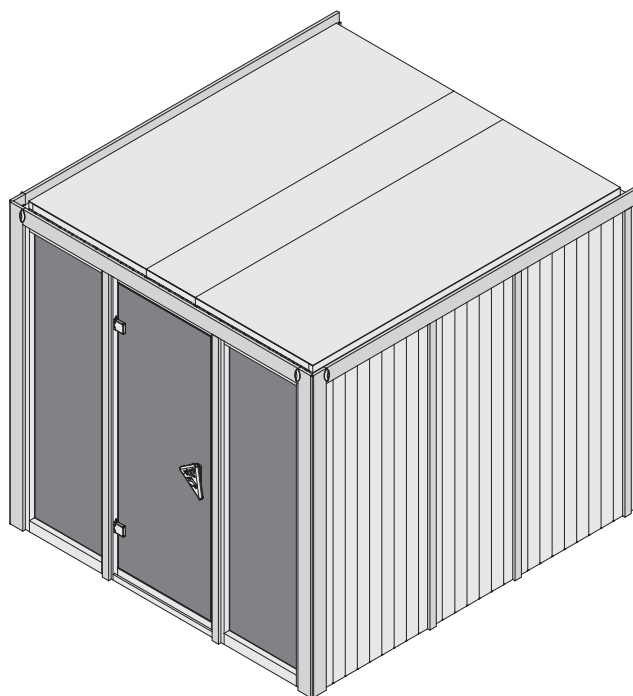

 **Aufbauanleitung**

 **Building Instructions**

 **notice de montage**

 **montagehandleiding**

 **Montagevejledning**

 **Instrucciones de construcción**

 **Istruzioni per il montaggio**

 **Montážní návod**

 **Navodila za sestavljanje**

Bitte bewahren Sie die Anleitung und den Garantieschein zur Seriennummer auf.

Vernichten Sie diese erst nach Ablauf der Garantiezeit.





Eventuelle Beanstandungen können mithilfe der Stückliste einfacher zugeordnet werden.

Beigelegte Dokumente

- Informationsheft
- Garantieschein zur Seriennummer
- Typenschild inkl. Warnhinweise (Sauna)
- ggf. Zubehör-Anleitungen in externen Paketen

- *  Nicht im Lieferumfang enthalten
 Not included
 Non comprises dans la livraison
 Niet bijgeleverd

-  No forman parte del suministro
 Non incluso
 V ceně není zahrnuto
 Ikke inkluderet
 Ni včlučeno v obseg dobave

- 1  Länge muss ermittelt und zugesägt werden
 Length must be determined and sawn
 La longueur doit être déterminée et sciée
 De lengte moet worden bepaald en worden gezaagd

-  La longitud debe ser determinada y aserrada
 La lunghezza deve essere determinata e segata
 Délka musí být určena a rozřezána
 Længden skal bestemmes og saves
 Določiti je treba dolžino in jo odrezati po velikosti.

- 2  Nicht gebraucht
 Not needed
 Pas nécessaire
 Niet nodig

-  No es necesario
 Non necessario
 Není nutná
 Ikke nødvendigt
 Ne uporabljaja se

- 3  Mit Zubehör
 With accessories
 Avec accessoires
 Met toebehoren

-  Con accesorios
 Con accessori
 S příslušenstvím
 Med tilbehør
 Z dodatki

- 4  Fixiert vorübergehend
 Fixed temporarily
 Temporairement fixe
 Tijdelijk vast

-  Temporalmente fijo
 Temporaneamente fisso
 Dočasně pevný
 Midlertidigt rettet
 Začasno popravi

- 5  Bestand vom Haus
 Inventory of the house
 Inventaire de la maison
 Inventaris von het huis

-  Inventario de la casa
 Inventario della casa
 Inventář domu
 Inventar af huset
 Inventarizacija hiše

 Vergleichen Sie zuerst die Material-liste mit Ihrem Paketinhalt! Bitte haben Sie Verständnis, dass Beanstandungen nur im nicht aufgebauten Zustand bearbeitet werden können!

 First compare the list of materials with your package contents! Please understand that complaints can be processed in the non-built status only!

 Commencez par comparer la liste du matériel avec le contenu de votre paquet! Sachez que nous traitons uniquement les réclamations concernant le matériel à l'état non monté!

 Vergelijk eerst de lijst van materialen met de inhoud van uw pakket! Reclamaties kunnen alleen in behandeling worden genomen zolang de onderdelen nog niet zijn gemonteerd!

 Start med at kontrollere materialelisten med indholdet af den leverede pakke! Vi gør venligst opmærksom på at reklamationer kun kan behandles for materialer som ikke er blevet bearbejdet!

 En primer lugar, compare la lista de material con el contenido del paquete. Rogamos entienda que las reclamaciones sólo pueden ser tramitadas antes de montar el objeto!

 Confrontate questa distinta materiali prima con il contenuto del pacchetto! Vi preghiamo di comprendere che eventuali reclami possono essere accolti solo prima del montaggio!

 Nejprve přezkontrolujte obsah balení podle materiálového listu! Mějte pochopení pro to, že případnou reklamaci se můžeme zabývat pouze tehdy, když díly nebudou smontované! Za pomoci tohoto seznamu můžete jednotlivé díly přiřadit k montážnímu návodu.

 Najprej primerajte zoznam materialov z vsebino vašega paketa! Upoštevajte, da lahko pritožbe obravnavamo le v nesestavljenem stanju!

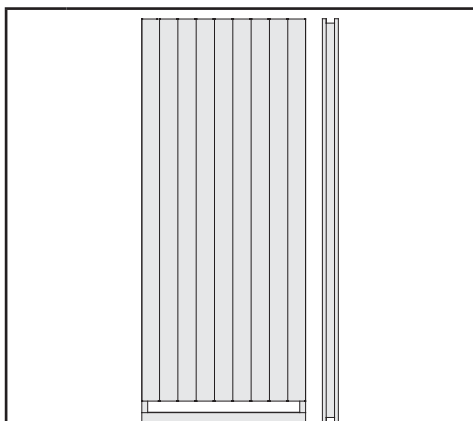
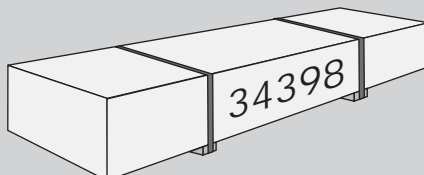

1 x W1 | 1920 x 780 x 68 mm | ID 24677

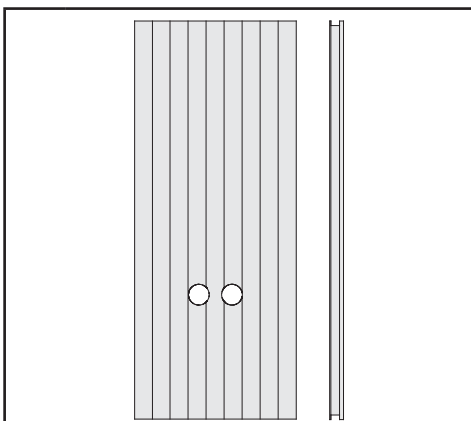

1 x W2 | 1920 x 780 x 57 mm | ID 70556

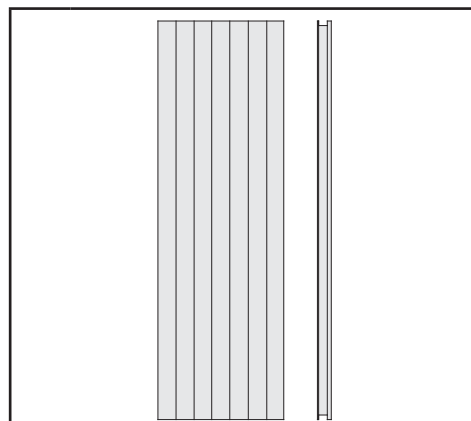

2 x W3 | 1920 x 606 x 57 mm | ID 23624

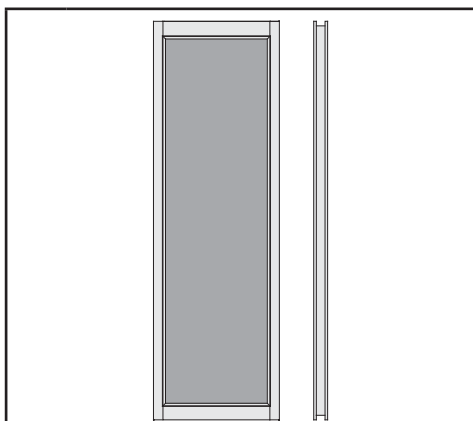

2 x W4 | 1920 x 606 x 68 mm | ID 47717

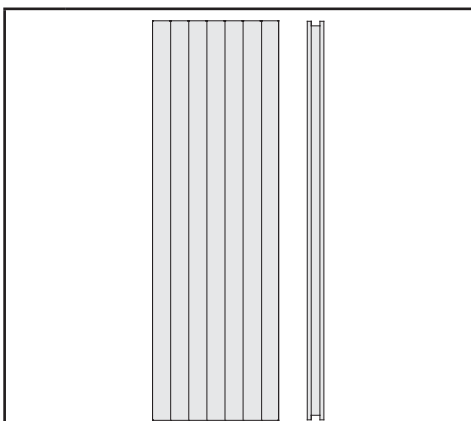

2 x W5 | 1920 x 606 x 68 mm | ID 25548

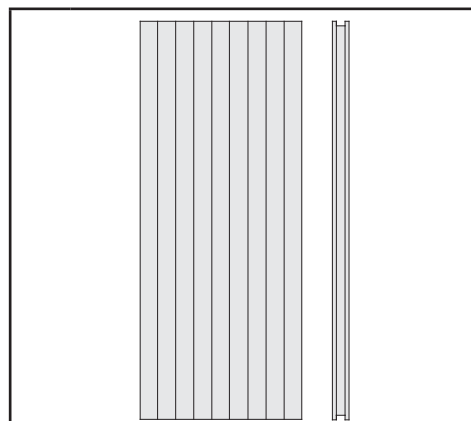

3 x W6 | 1920 x 780 x 68 mm | ID 25549

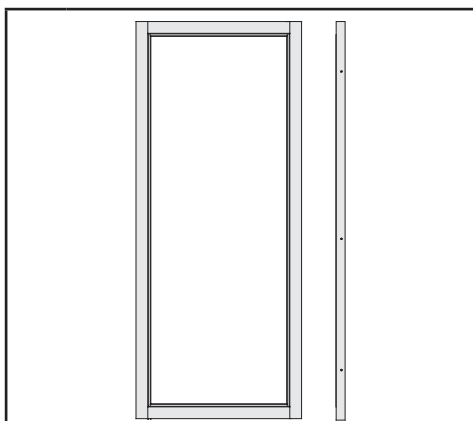

1 x X1 | | ID 26499

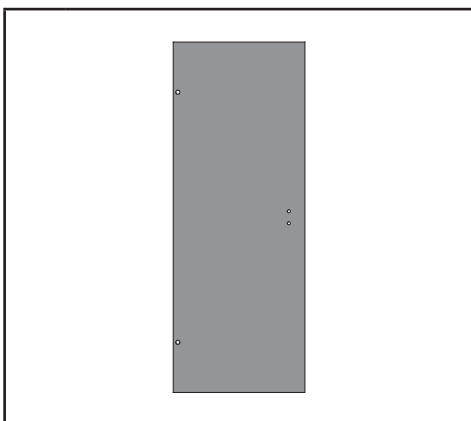

1 x X2 | | ID 26494

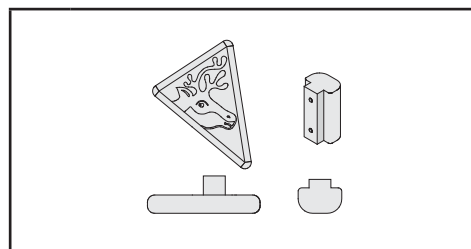

1 x X3 | | ID 26114

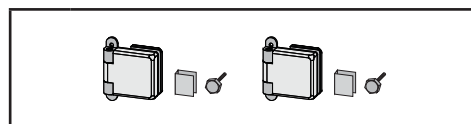

1 x X4 | | ID 26496

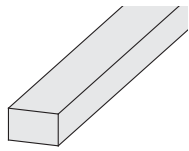

9 x B1	1920 x 19 x 3 mm	ID 20799
4 x B2	750 x 36 x 12 mm	ID 24239
4 x B3	1920 x 36 x 12 mm	ID 24846
1 x B4	1244 x 90 x 16 mm	ID 2255
2 x B5	1985 x 90 x 16 mm	ID 36745
8 x B6	1884 x 45 x 17 mm	ID 48037
3 x B7	2285 x 95 x 18 mm	ID 52838
1 x B8	300 x 120 x 18 mm	ID 22467
2 x B9	256 x 42 x 28 mm	ID 9837
2 x B10	500 x 42 x 28 mm	ID 36747
2 x B11	550 x 42 x 28 mm	ID 83494
2 x B12	1100 x 42 x 28 mm	ID 24097
2 x B13	1938 x 42 x 28 mm	ID 54142
4 x B14	2018 x 42 x 28 mm	ID 52821
2 x B15	2163 x 42 x 28 mm	ID 54143
4 x B16	2272 x 42 x 28 mm	ID 52837
2 x B17	1874 x 52 x 52 mm	ID 26165

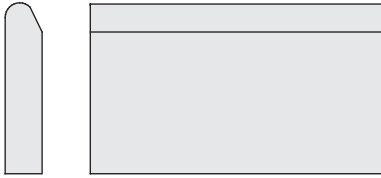

4 x G1	1980 x 95 x 17 mm	ID 48540
--------	-------------------	----------

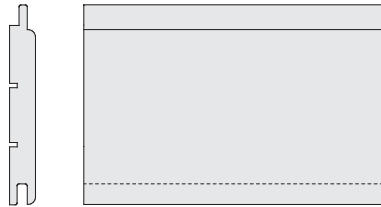

2 x R1	1920 x 97 x 12 mm	ID 22863
--------	-------------------	----------

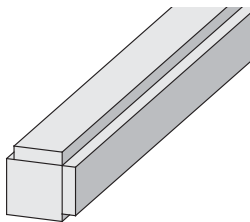

2 x K1	1874 x 64 x 64 mm	ID 24725
--------	-------------------	----------



1 x M1	349 x 2189 x 57 mm	ID 45227
2 x M2	836 x 2189 x 57 mm	ID 37073

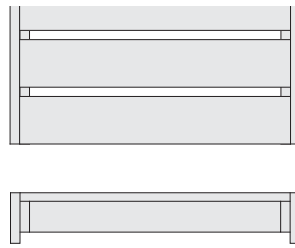

1 x L1	1260 x 550 x 95 mm	ID 52062
2 x L2	1985 x 550 x 95 mm	ID 36746

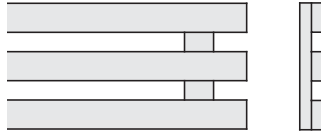

1 x L3	528 x 174 x 32 mm	ID 6917
2 x L4	1305 x 174 x 32 mm	ID 13892
2 x L5	1983 x 174 x 32 mm	ID 38153

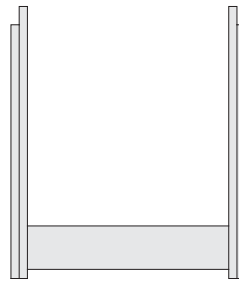

1 x H1	895 x 512 x 95 mm	ID 16811
--------	-------------------	----------

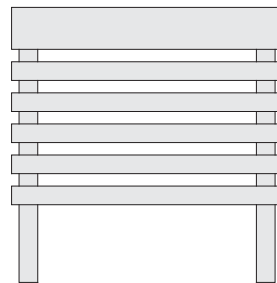

2 x Q1	474 x 630 x 32 mm	ID 2252
2 x Q2	580 x 630 x 32 mm	ID 2253

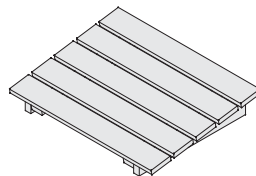

1 x	400 x 300 x 80 mm	ID 20708
-----	-------------------	----------

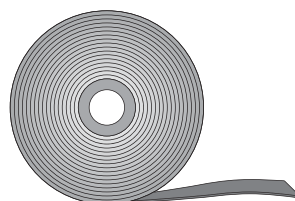

1 x	10 m	ID 14025
-----	------	----------

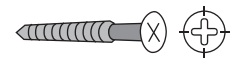

65 x	4 x 30 mm	ID 3686
50 x	4 x 50 mm	ID 3688
50 x	4 x 70 mm	ID 3689
45 x	4,5 x 80 mm	ID 9204
35 x	6 x 60 mm	ID 14014

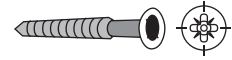

110 x	4,5 x 40 mm	ID 26285
-------	-------------	----------

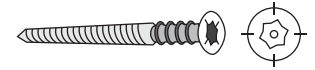

6 x	6 x 80 mm	ID 14266
-----	-----------	----------



6 x		ID 46403
110 x		ID 26116

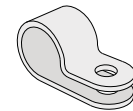

1 x		ID 50420
-----	--	----------

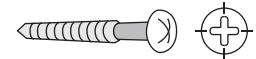

6 x	3 x 16 mm	ID 46376
-----	-----------	----------

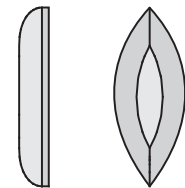

4 x		ID 26272
-----	--	----------

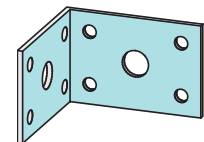

2 x		ID 21292
-----	--	----------

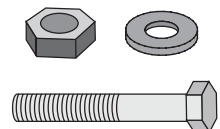

3 x		ID 42172
-----	--	----------

Übersicht
Overview
enquête

overzicht
undersøgelse
estudio

sondaggio
přehled
Pregled

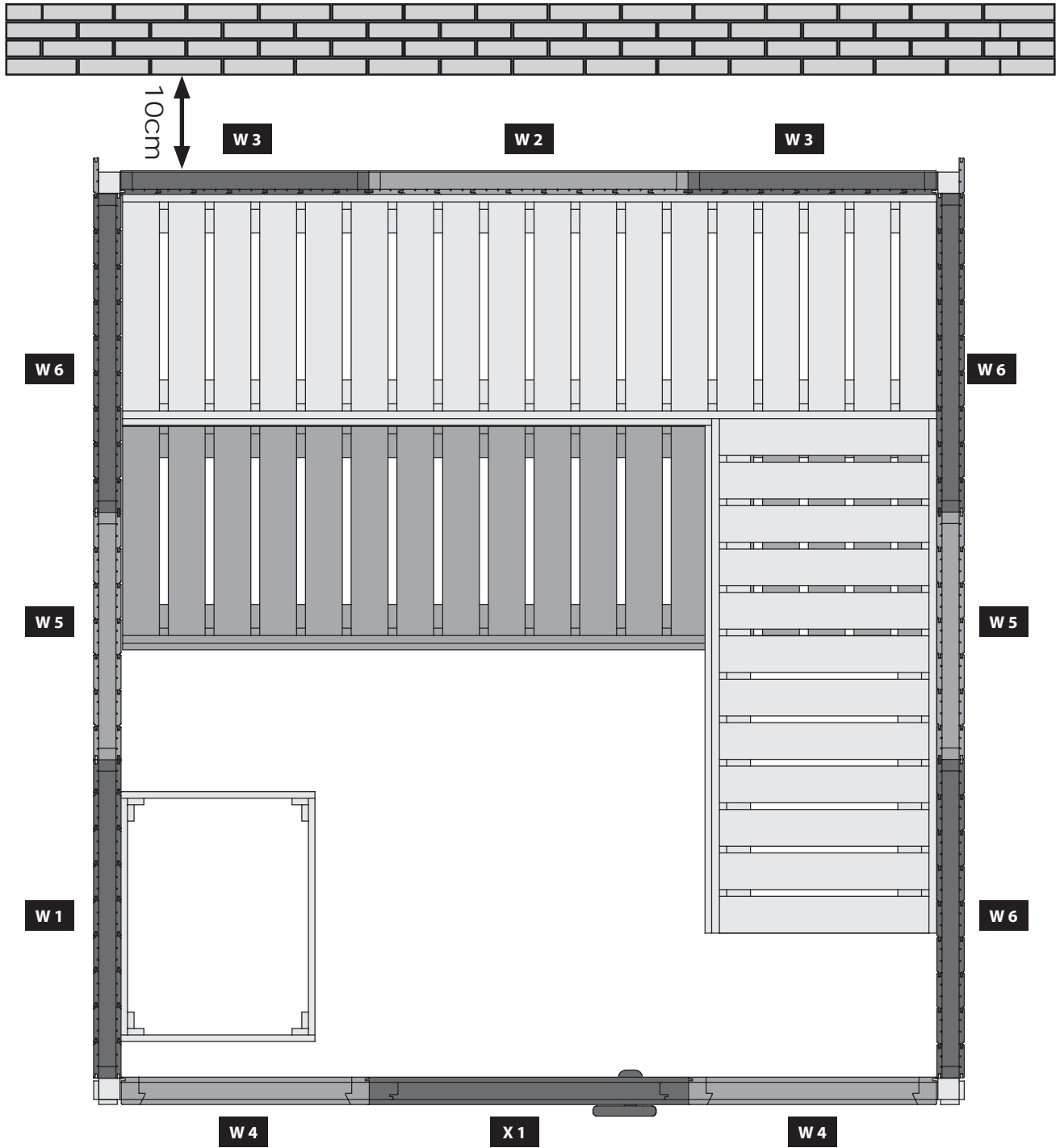

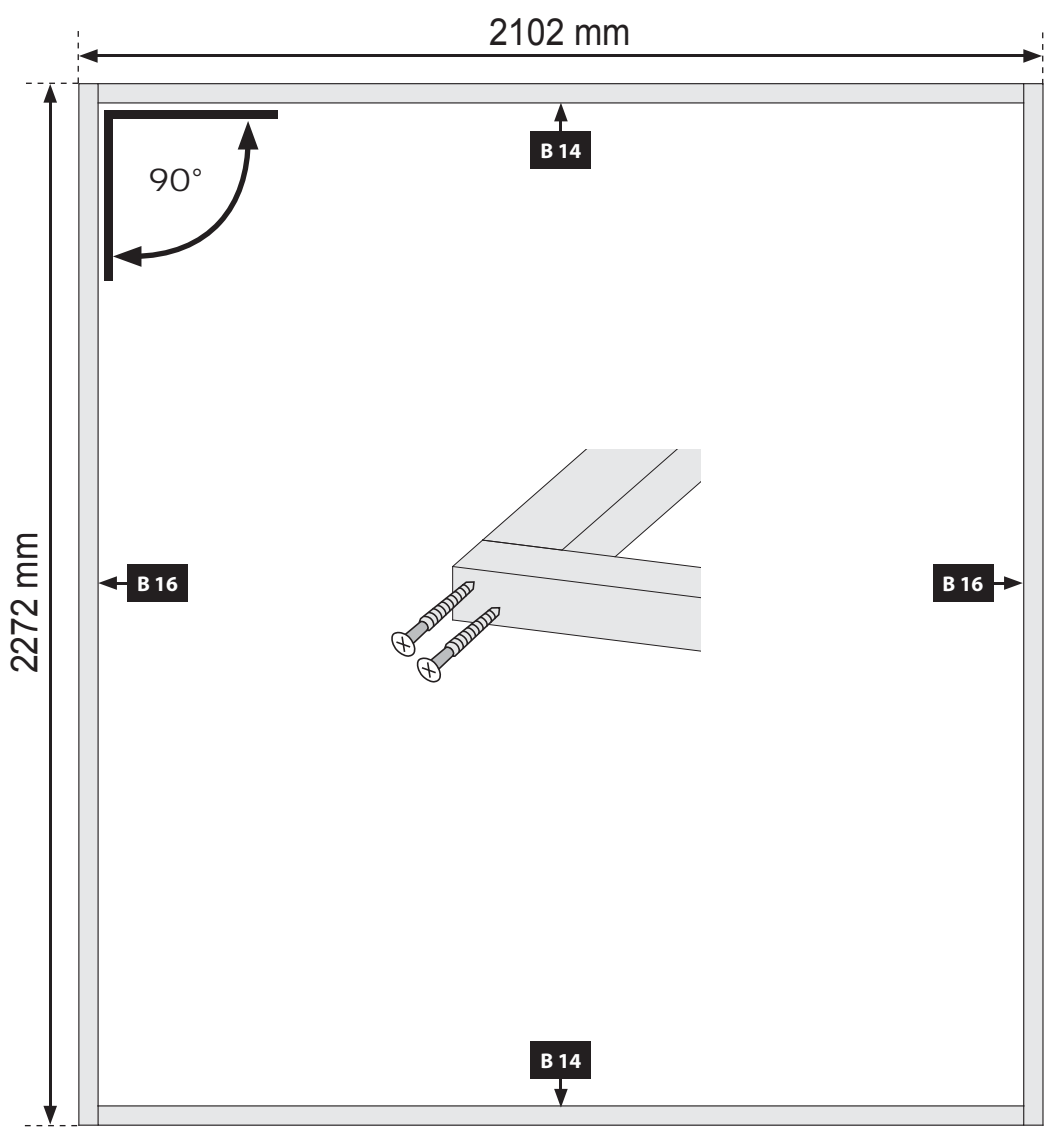
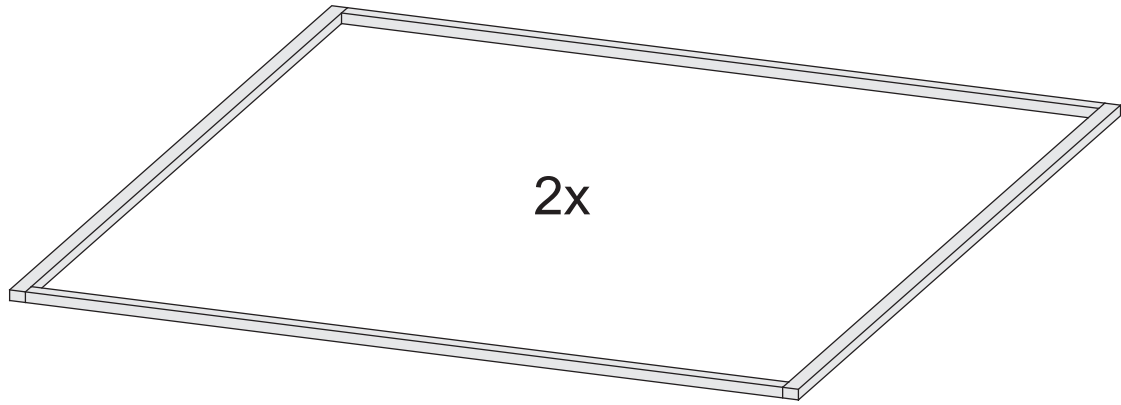
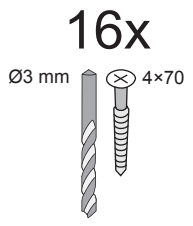
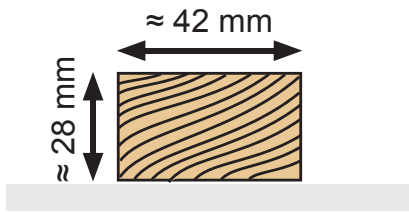

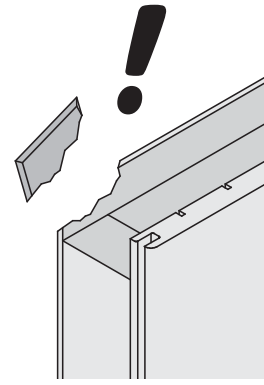
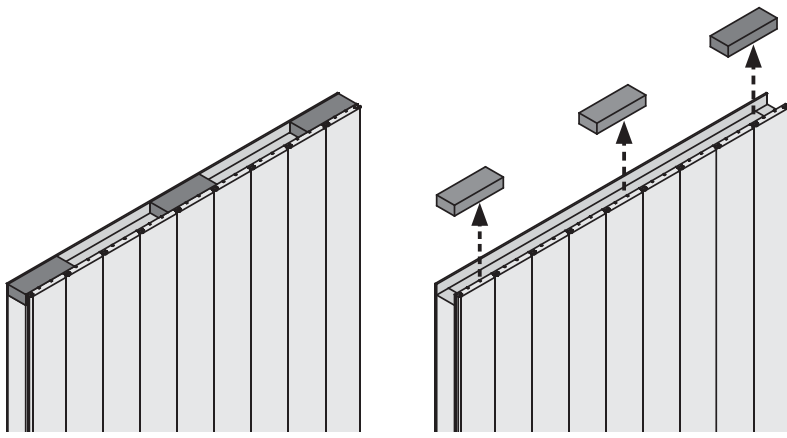

-  Vorsicht!
-  Voorzichtig!
-  Attention!
-  Attention!
-  Cuidado!
-  Occhio!
-  Pozor!
-  Opozorilo!

02

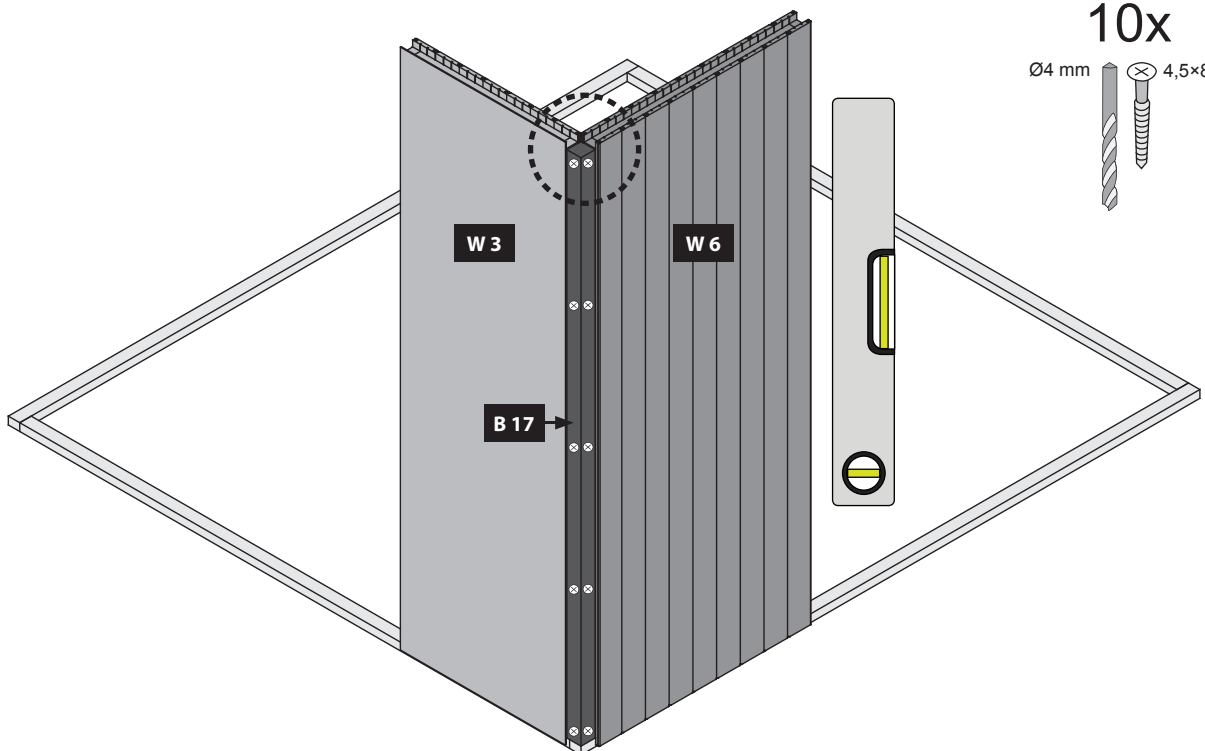
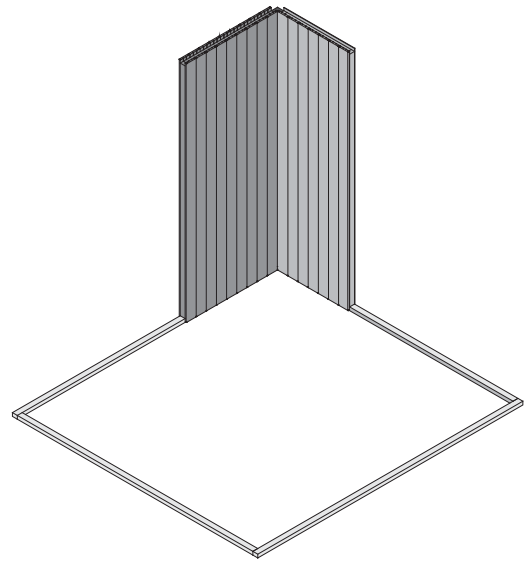
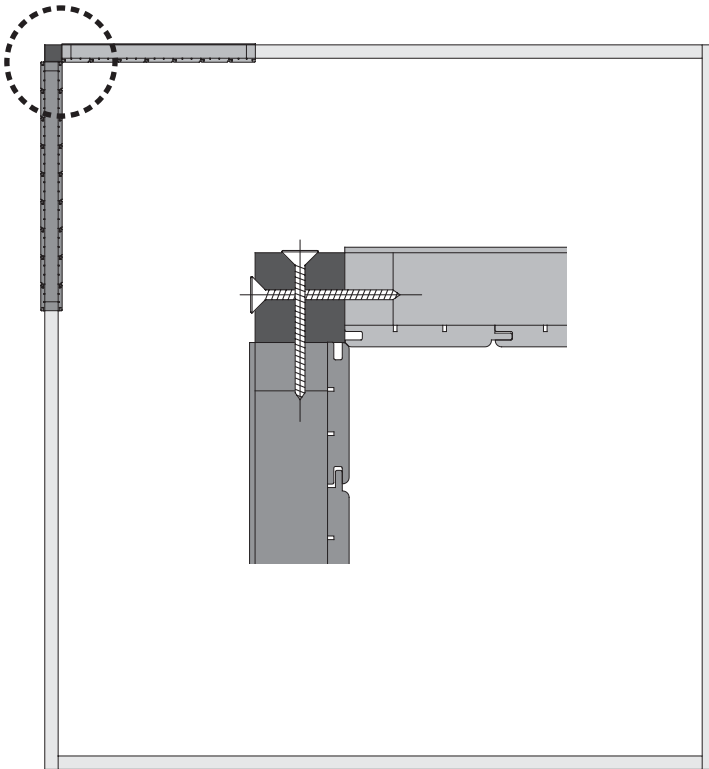

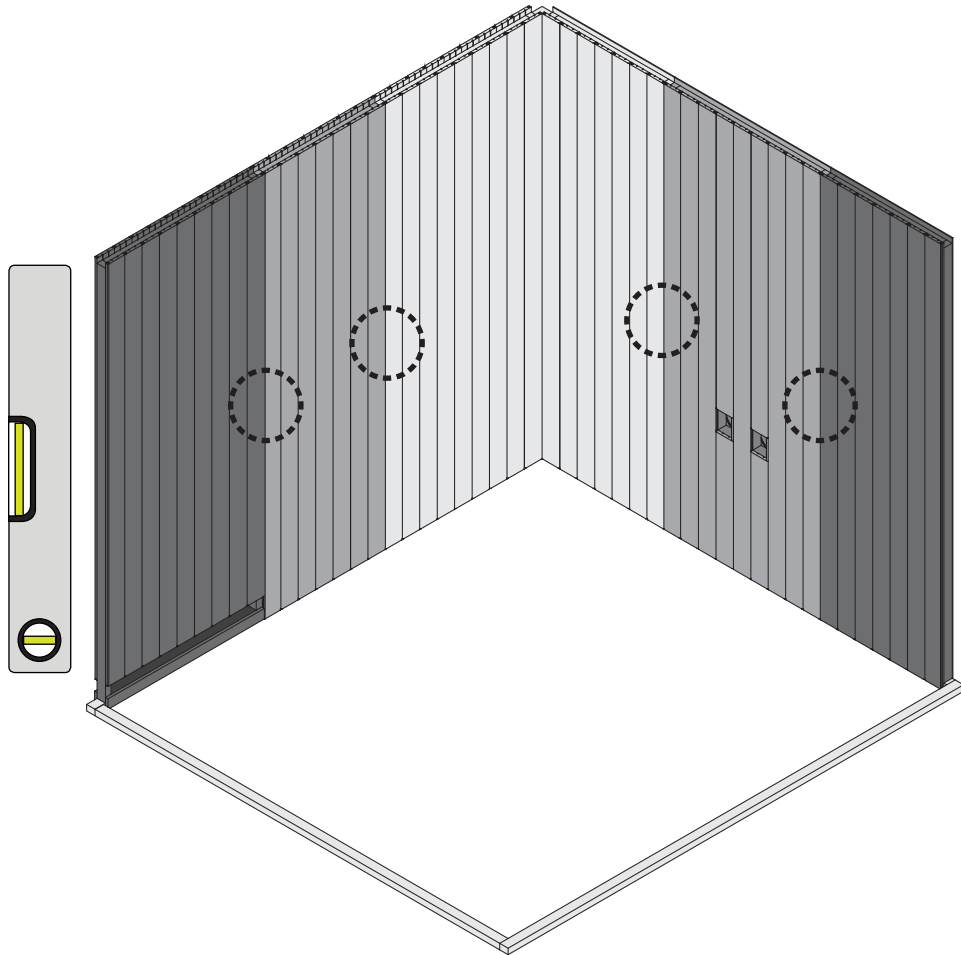
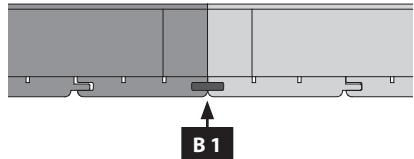
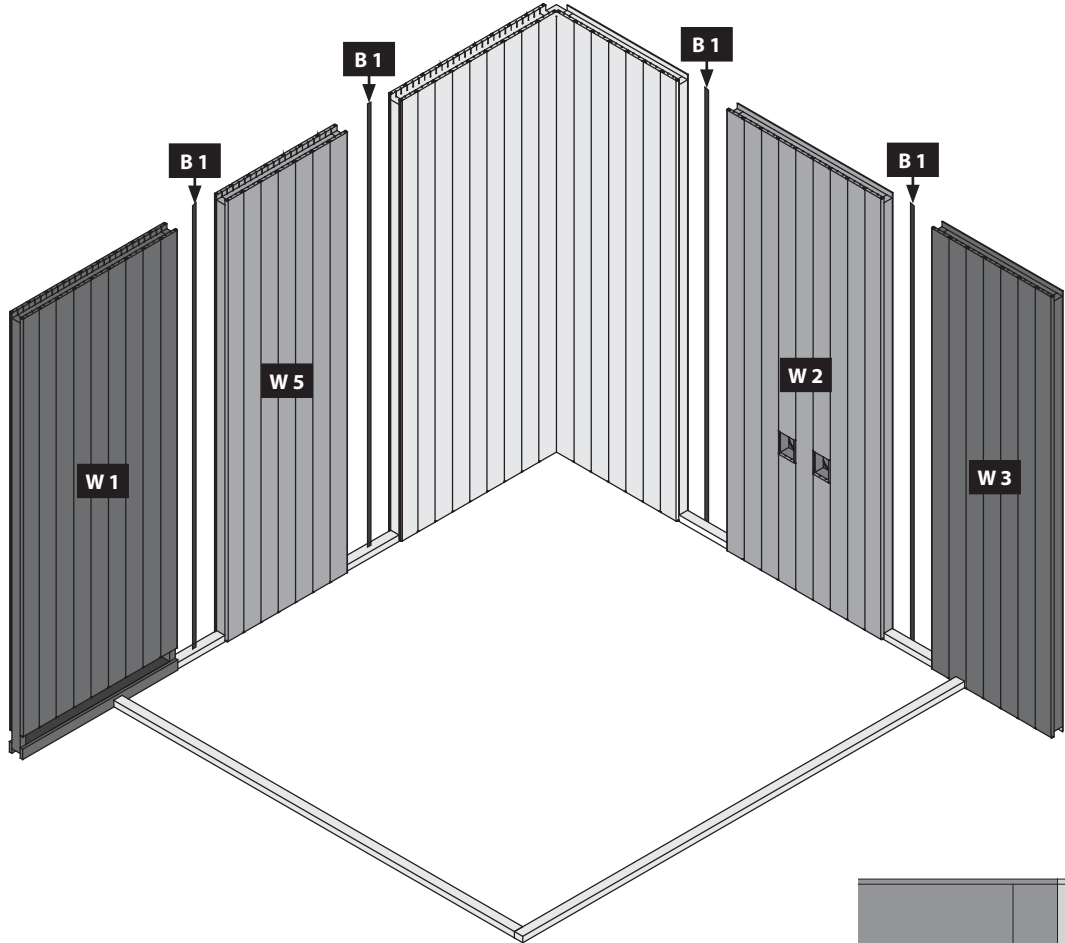

10x

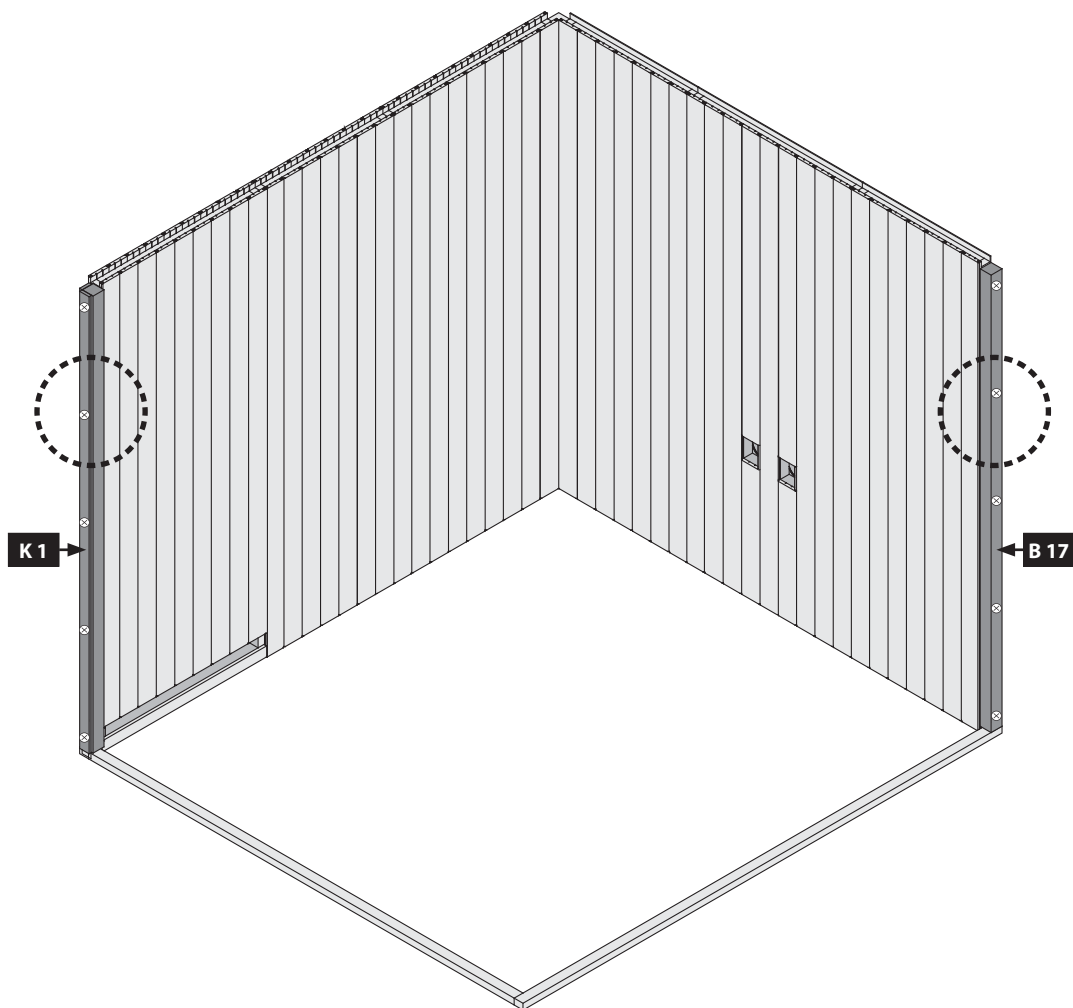
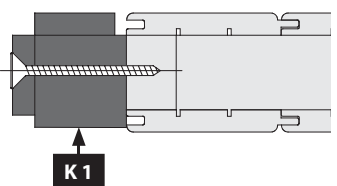
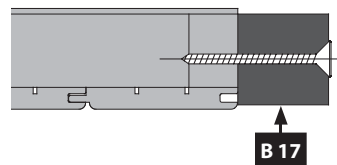
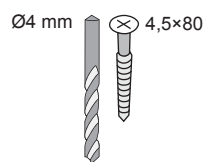

5x

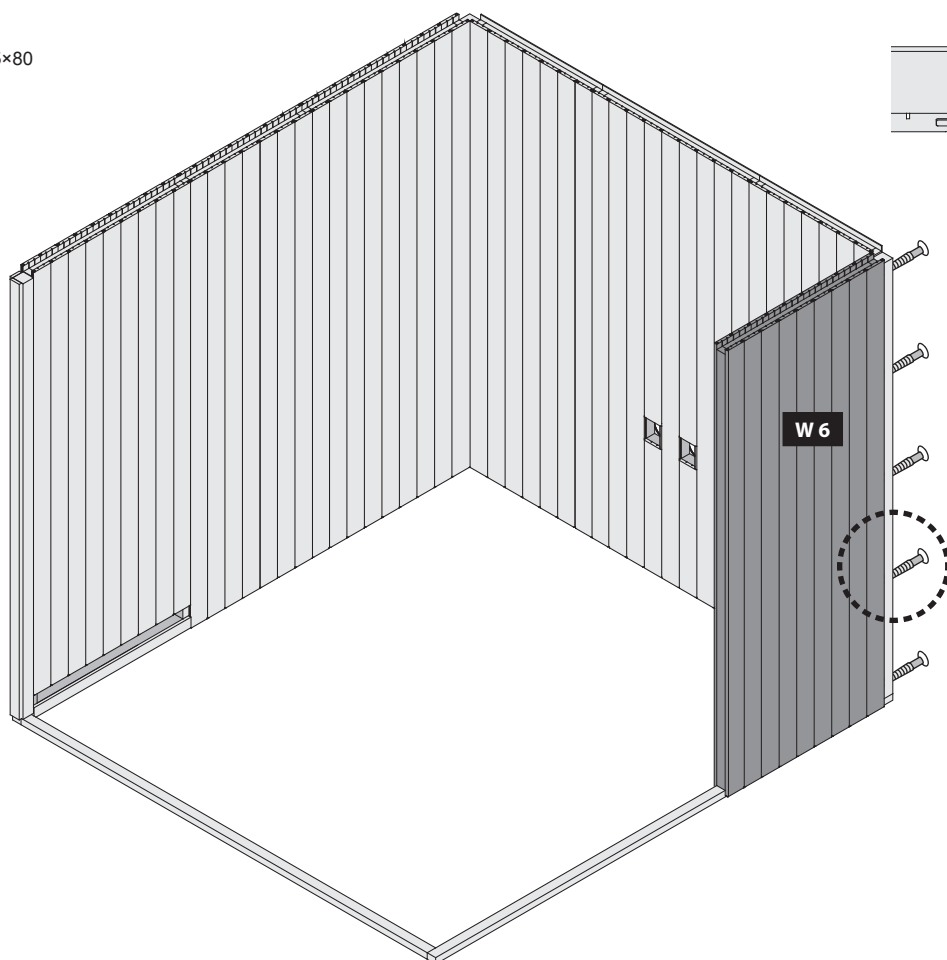
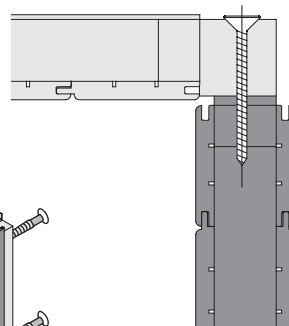
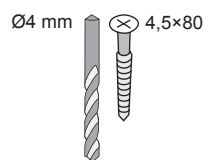

5x

Ø4 mm 4,5x80

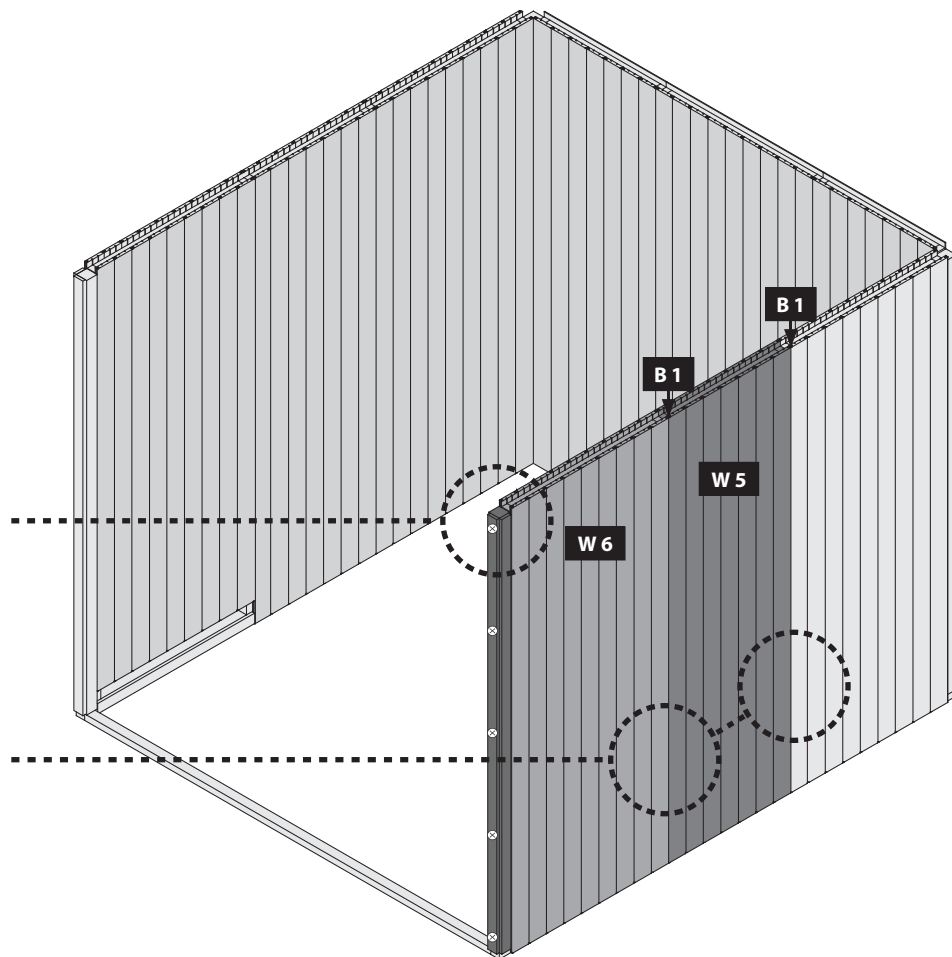
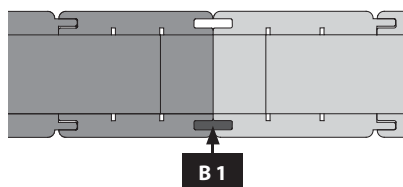
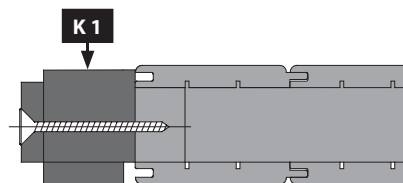
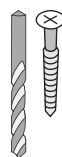



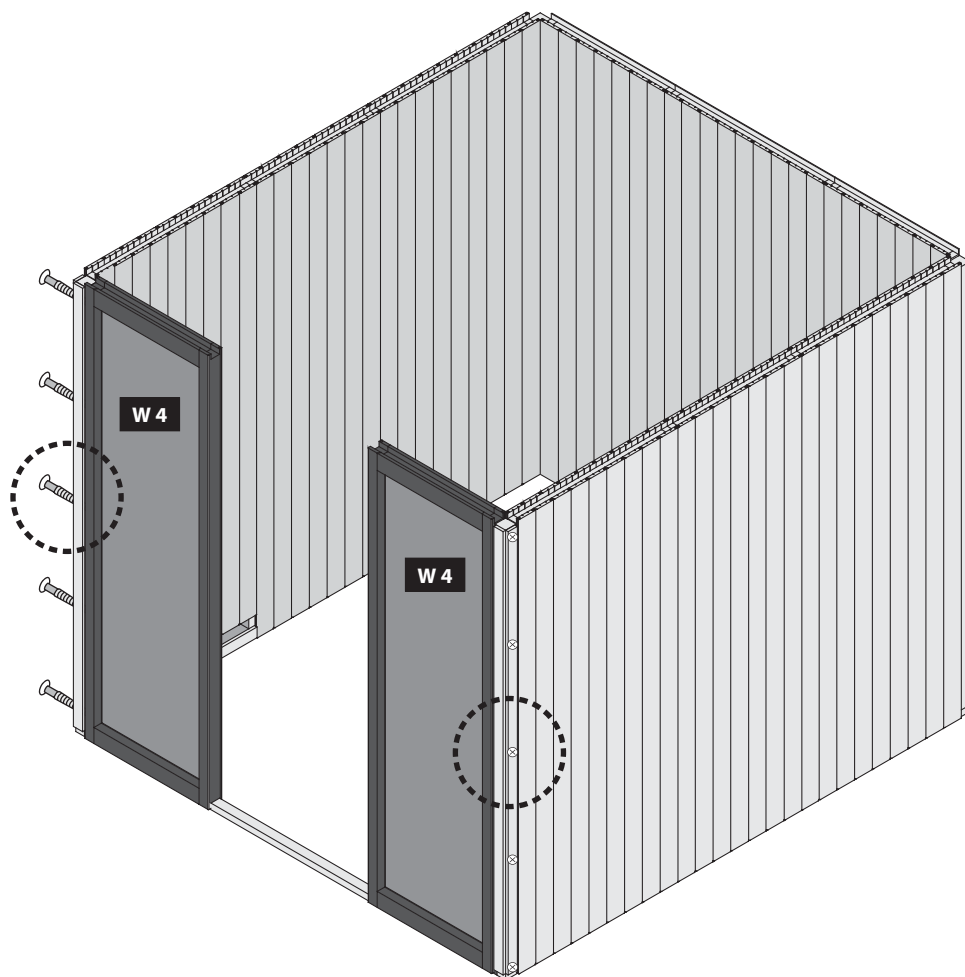
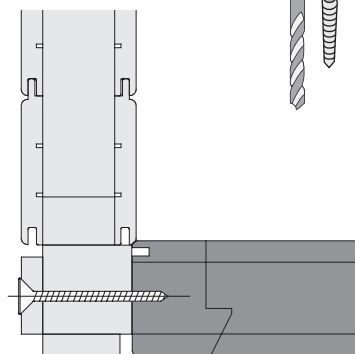
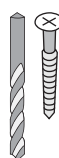

10x

Ø4 mm 4,5x80



-  Einbau Glastür
-  Installation of glass door
-  Montage porte en verre
-  Montage van de glazen deur
-  Installationsglasdør

-  Montaje de la puerta de cristal
-  Installazione portello di vetro
-  Sauna Instalace dveře
-  Vgradnja steklenih vrat

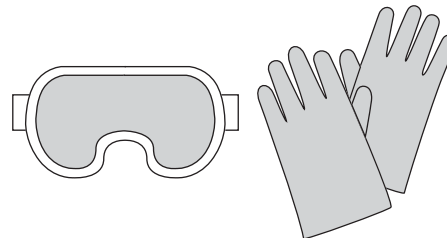

08

-  Tür in den Rahmen legen
-  Put the door in the frame
-  Mettez la porte dans le cadre
-  Plaats de deur in het frame
-  Sæt døren i rammen
-  Pon la puerta en el marco
-  Metti la porta nel telaio
-  Vložte dveře do rámu
-  Vrata namestite v okvir

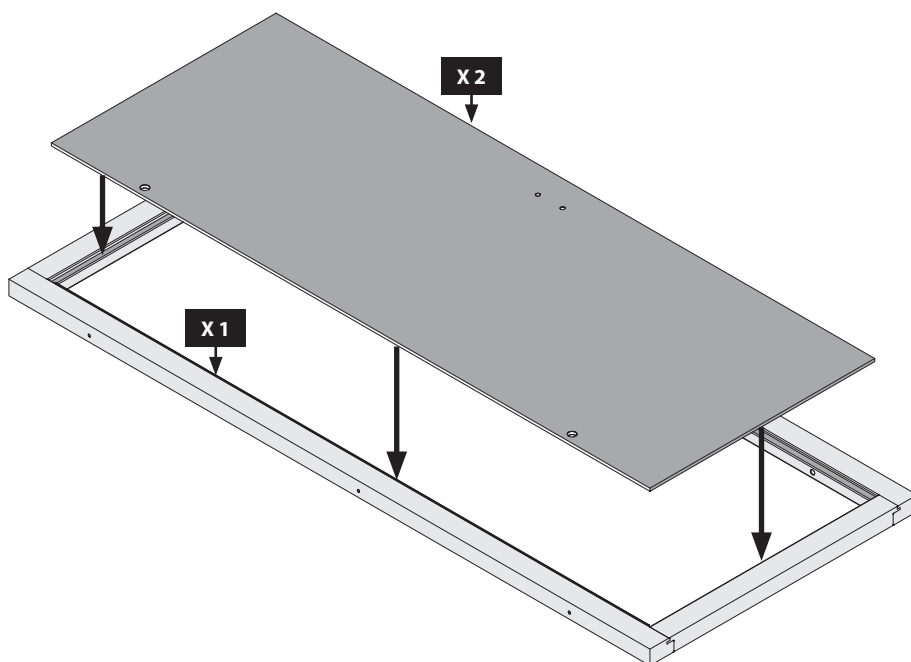

-  Tür im Rahmen ausrichten
-  Center the door in the frame
-  Aligner la porte dans le cadre
-  Lijn de deur in het frame uit
-  Juster døren i rammen
-  Alinea la puerta en el marco
-  Allinea la porta nella cornice
-  Zarovnejte dveře do rámu
-  Poravnajte vrata v okvir

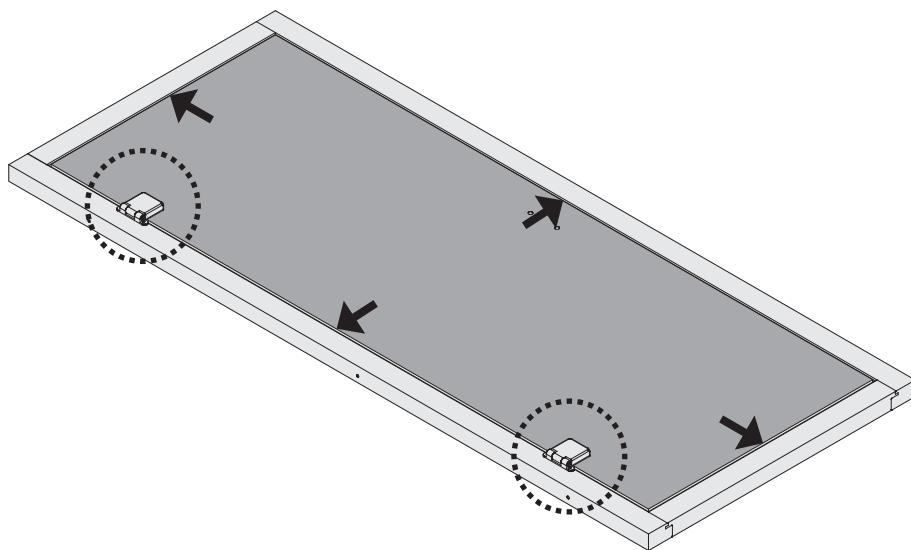

1.

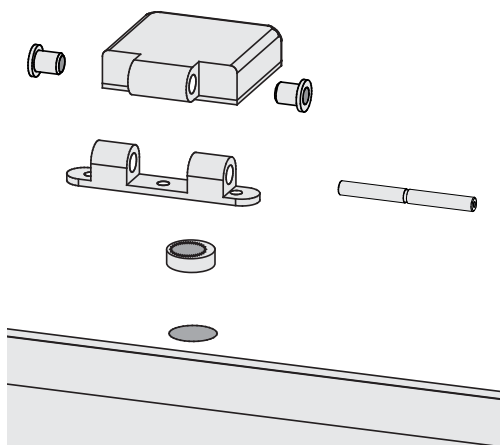

2.

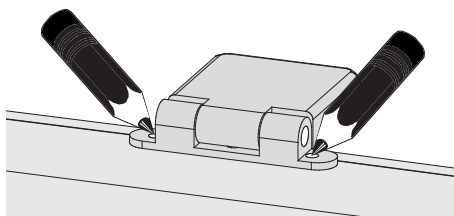

3.

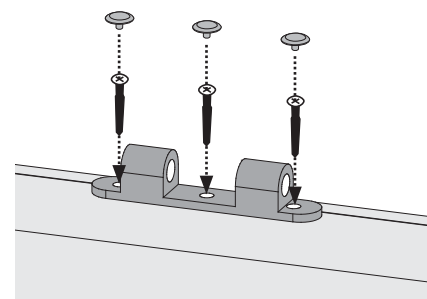

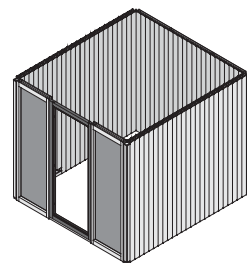
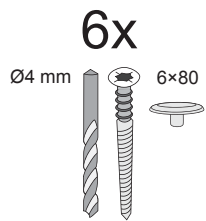

X 1

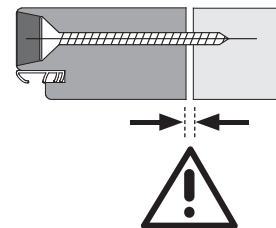
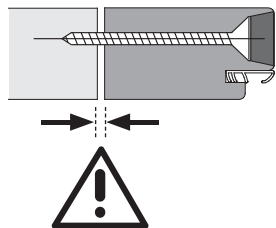
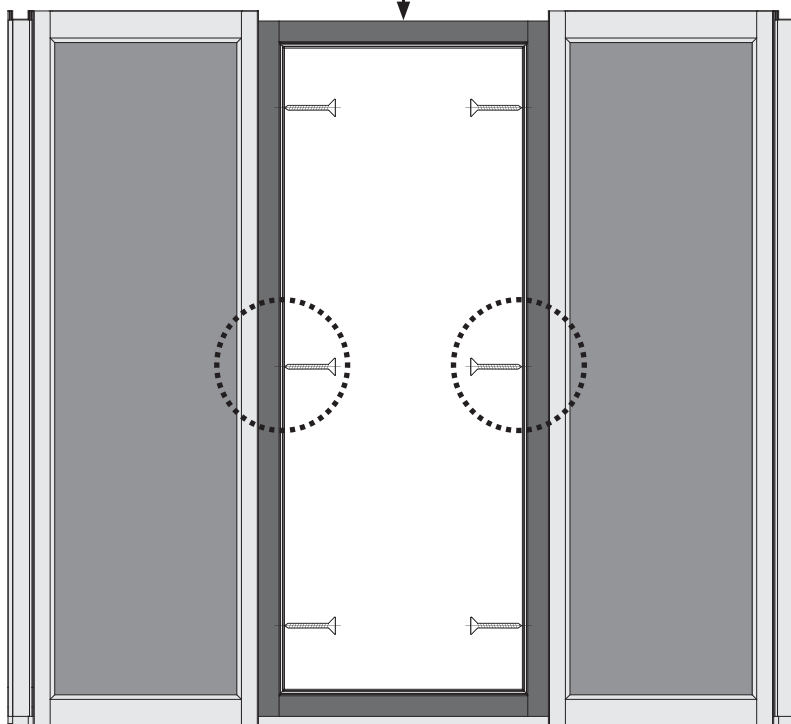

01 !

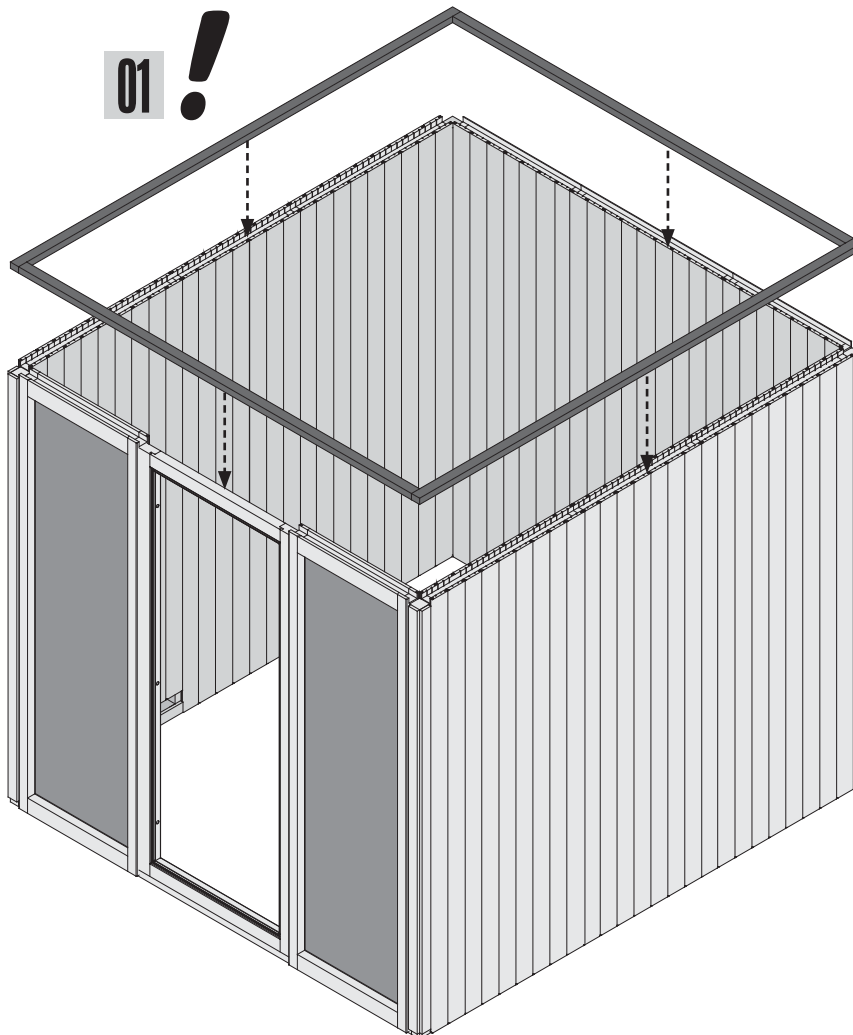

-  Bündig!
-  Flush!
-  Affleurement!
-  Gelijk!
-  I flugt!
-  Aras!
-  Combacia!
-  Stejný!
-  Splakovanje!

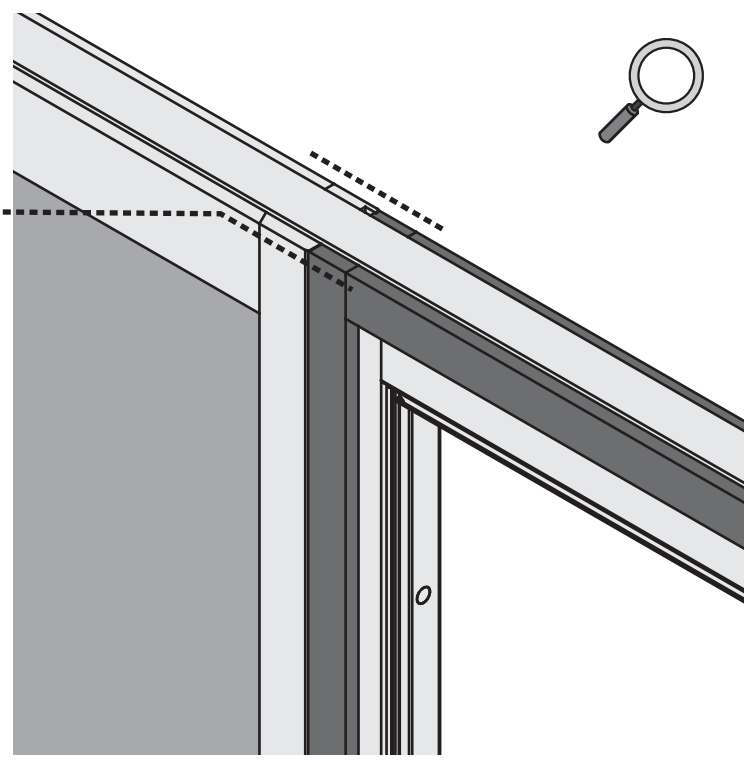

28x

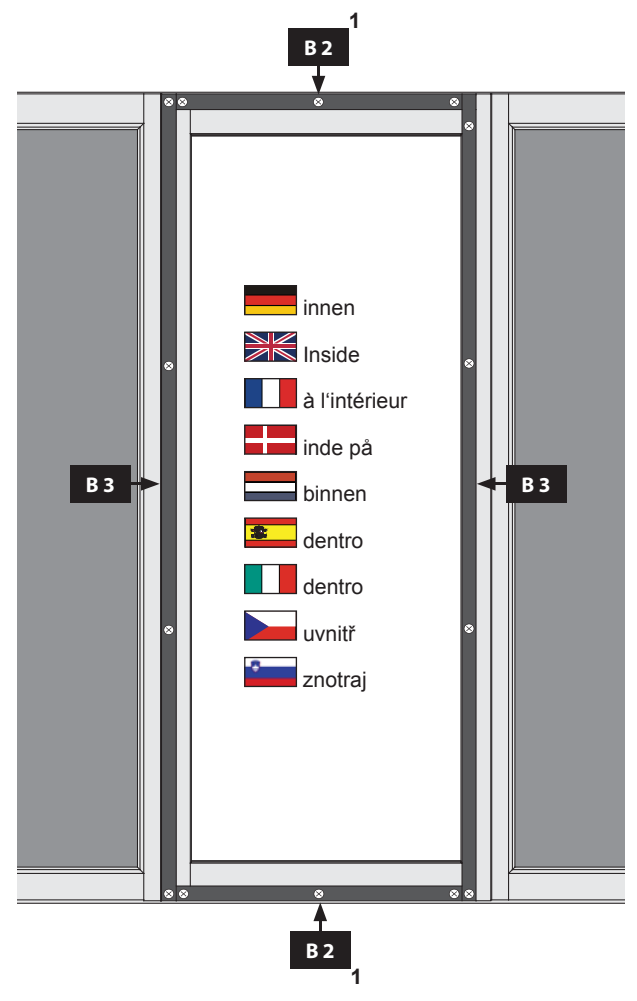
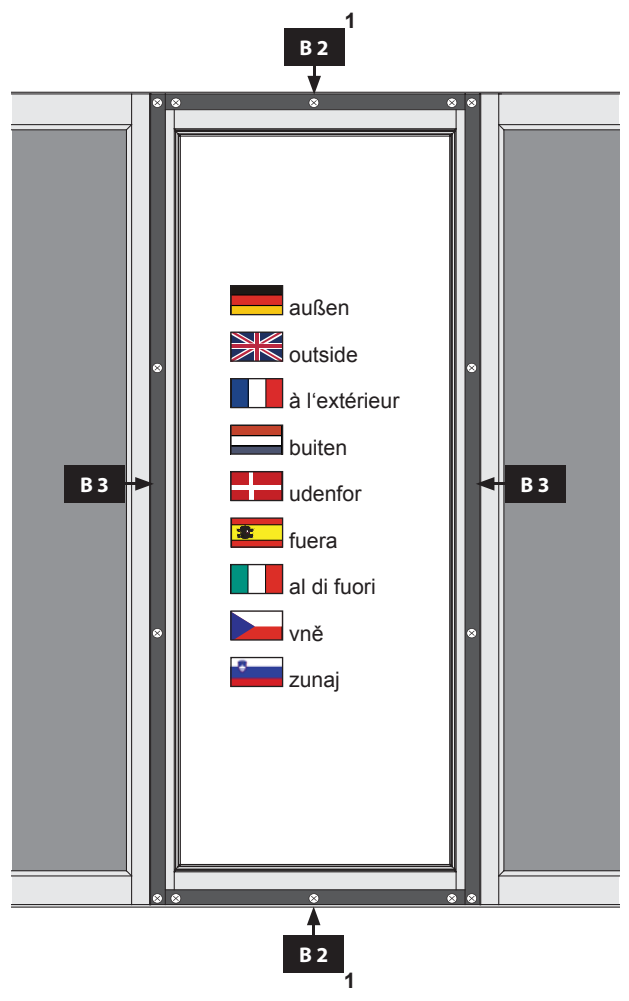
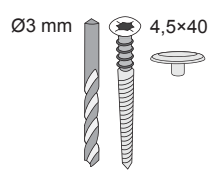

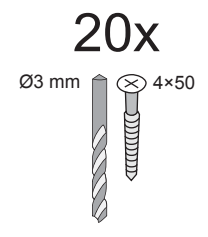
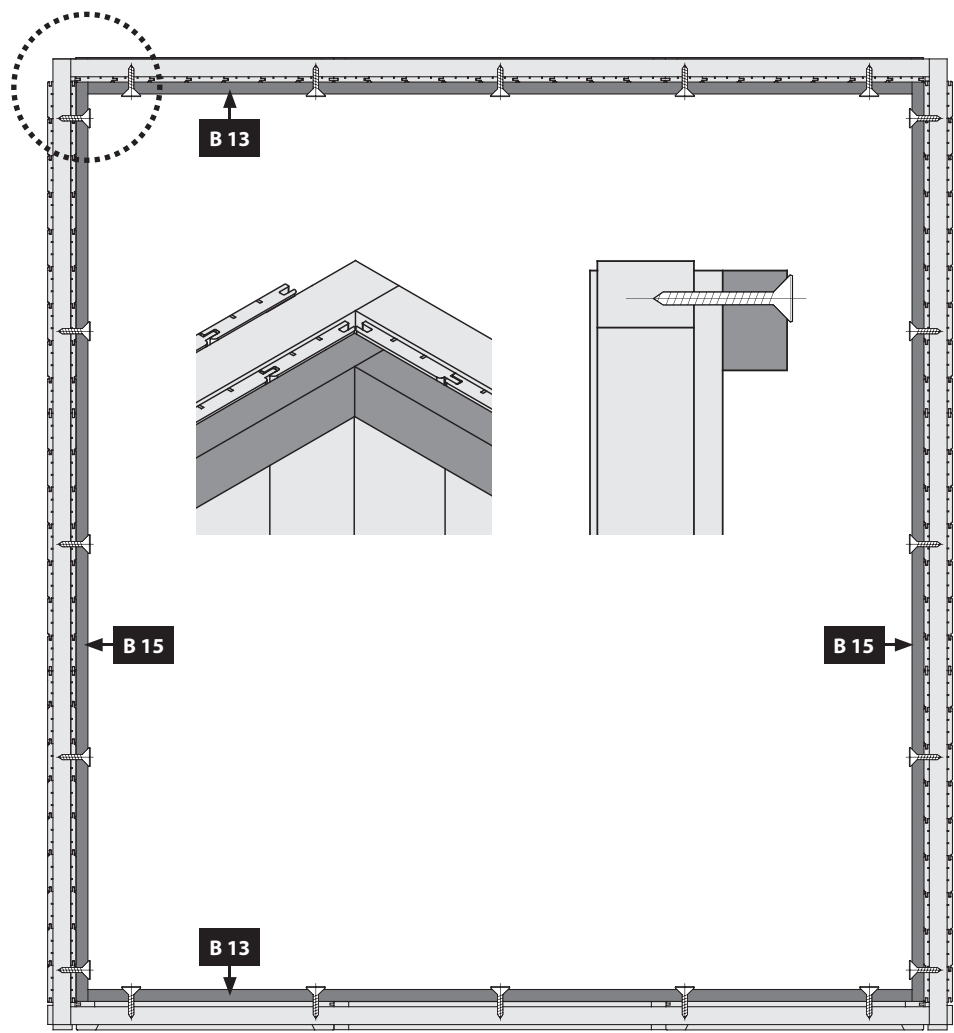

-  Draufsicht
-  Top view
-  vue de dessus
-  Øverste visning
-  bovenaanzicht
-  vista desde arriba
-  vista dall'alto
-  pŮdorys
-  Pohľad od zgoraj

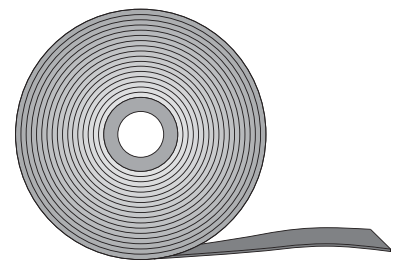
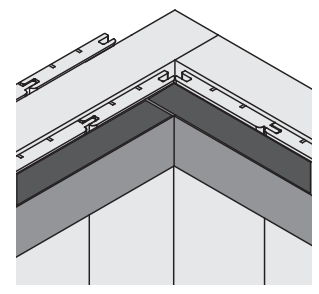
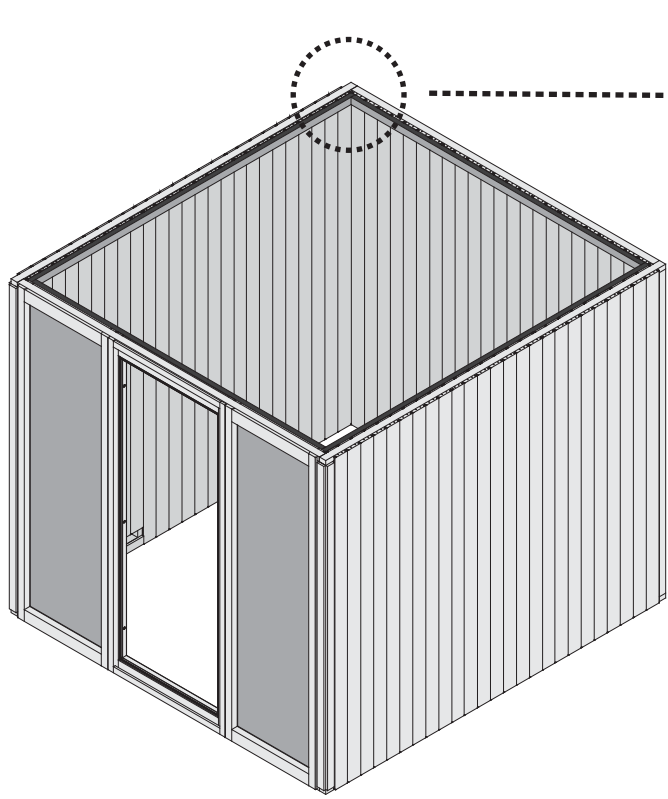

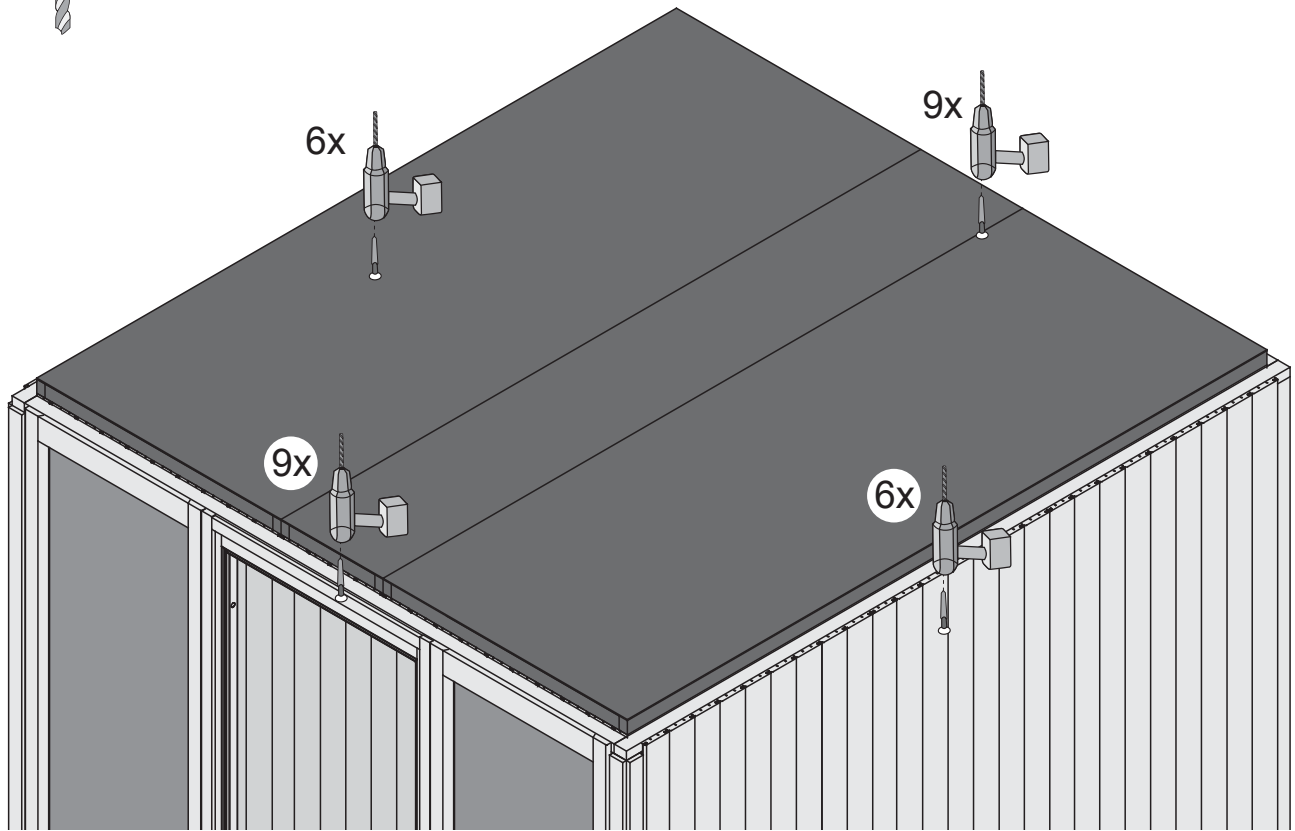
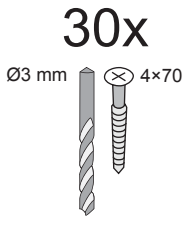
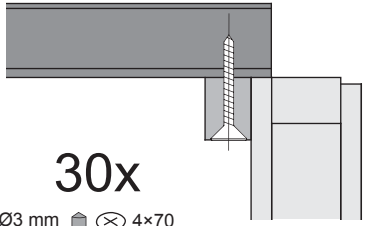
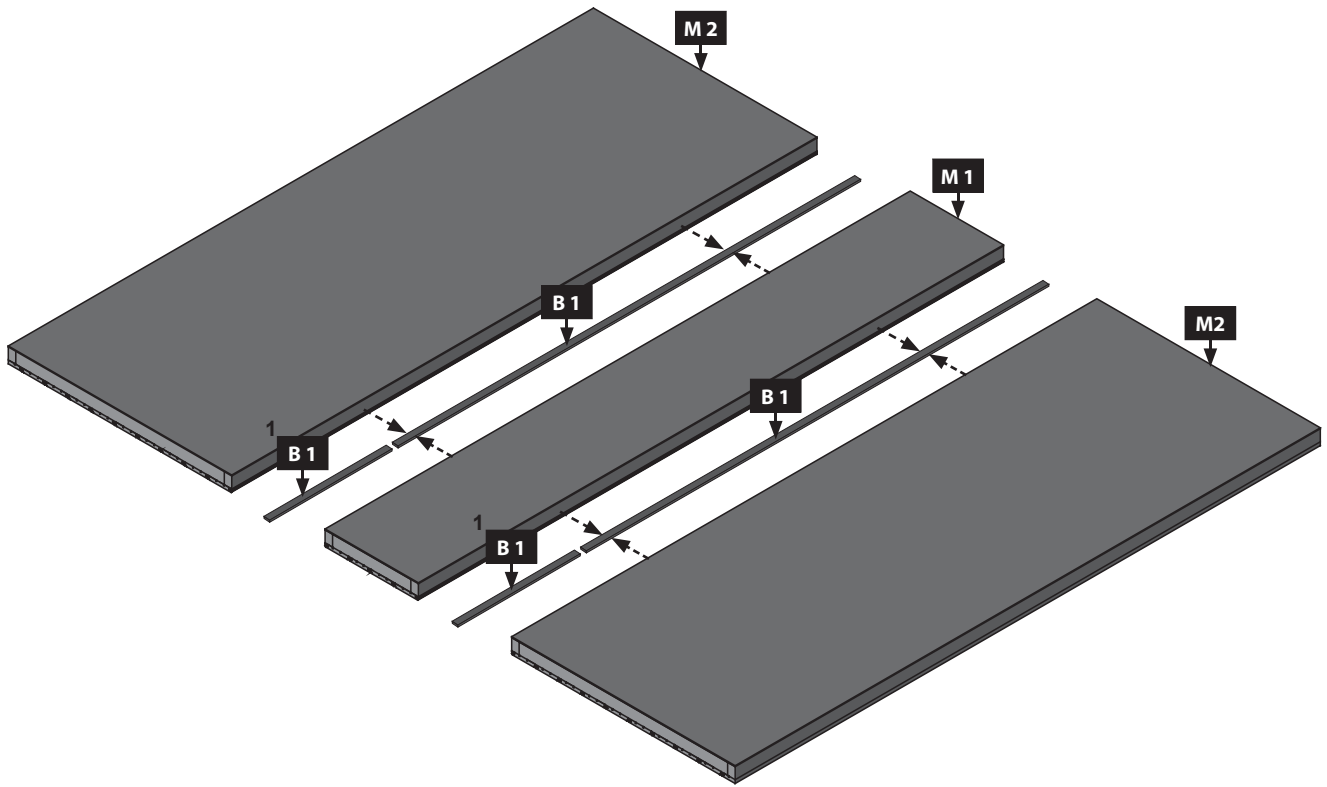

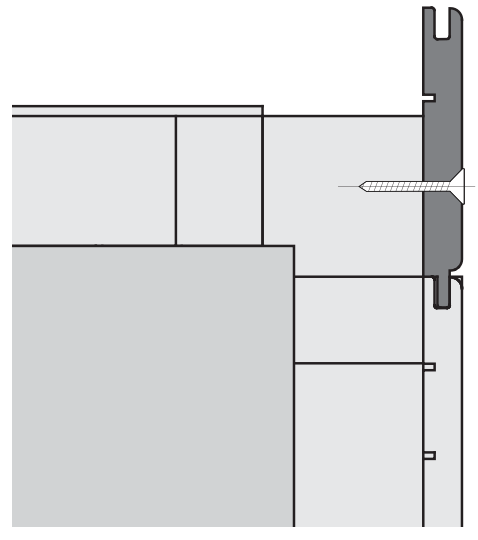
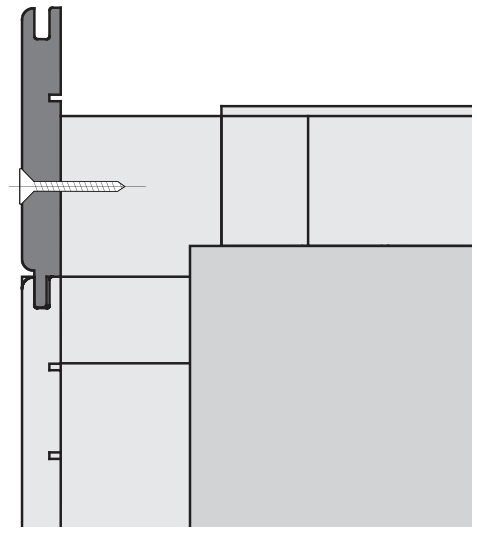
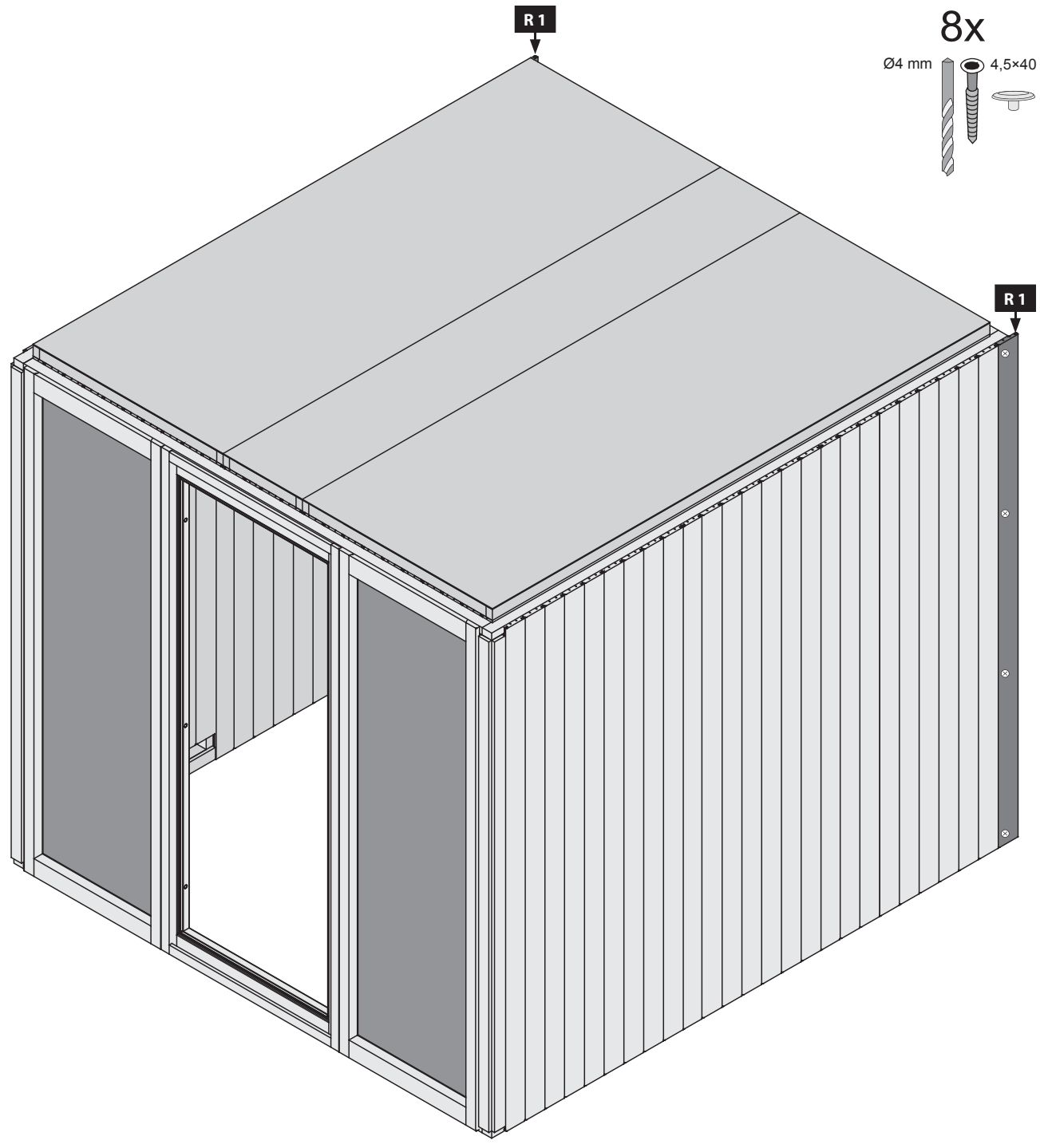

16x

Ø4 mm 4,5x40

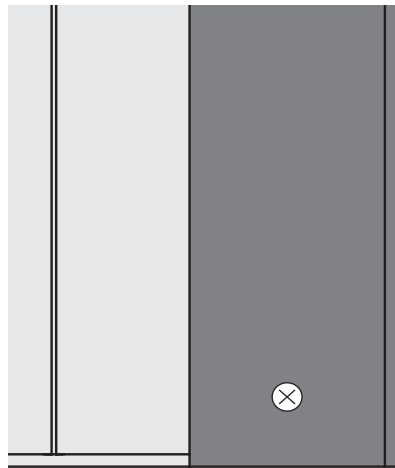
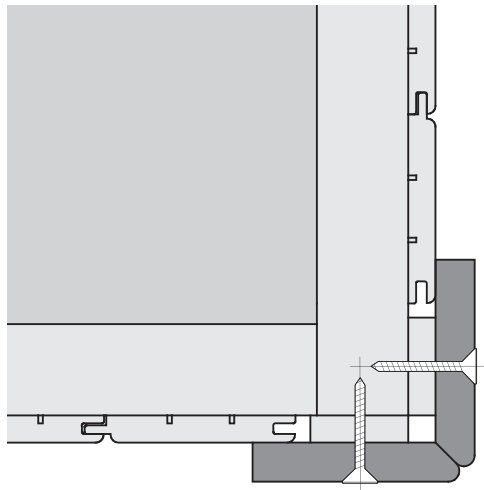
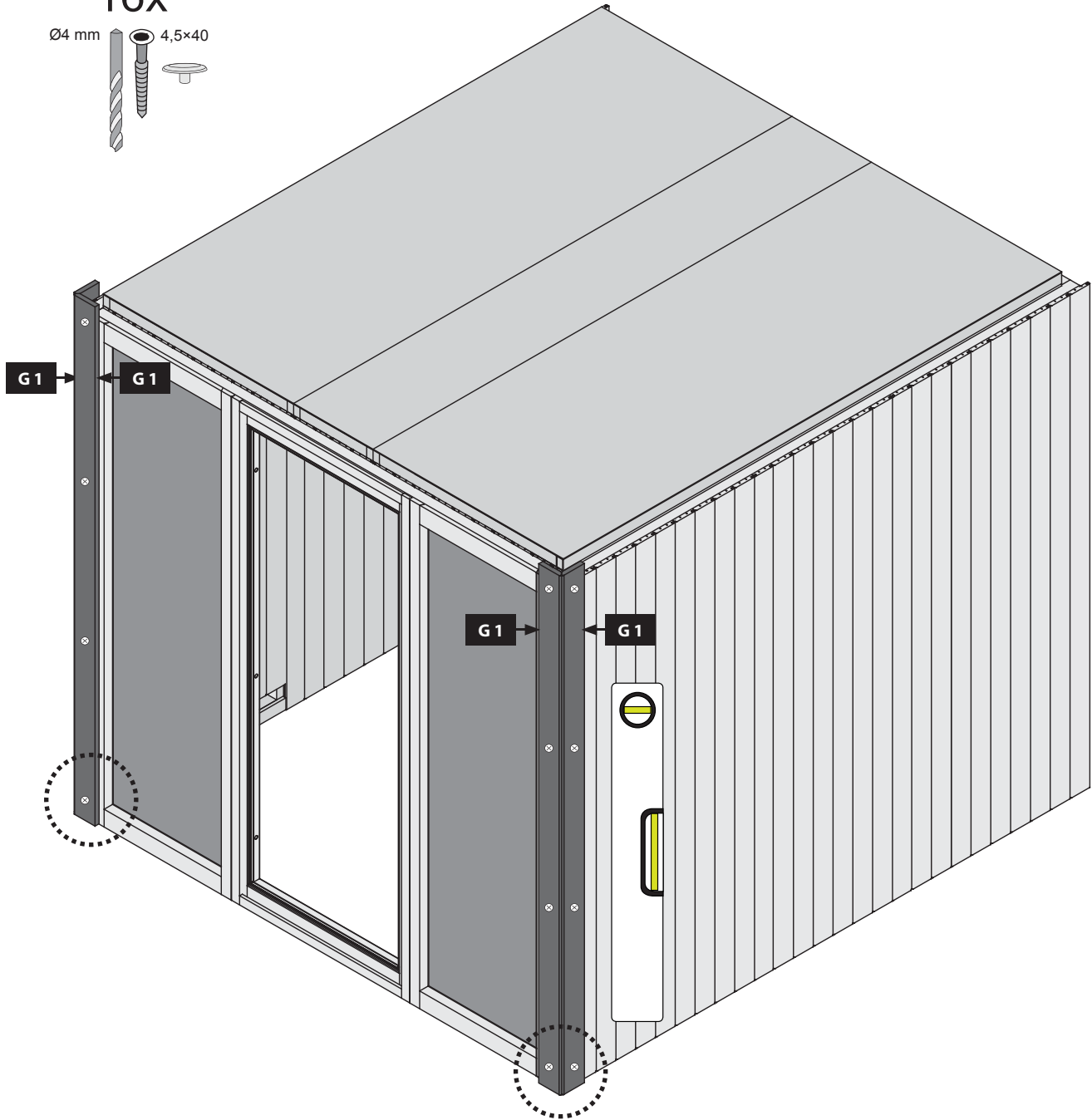
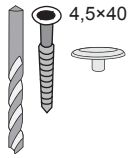

-  Bündig!
-  Flush!
-  Affleurement!
-  Gelijk!
-  I flugt!
-  Aras!
-  Combacia!
-  Stejný!
-  Splakovanie!

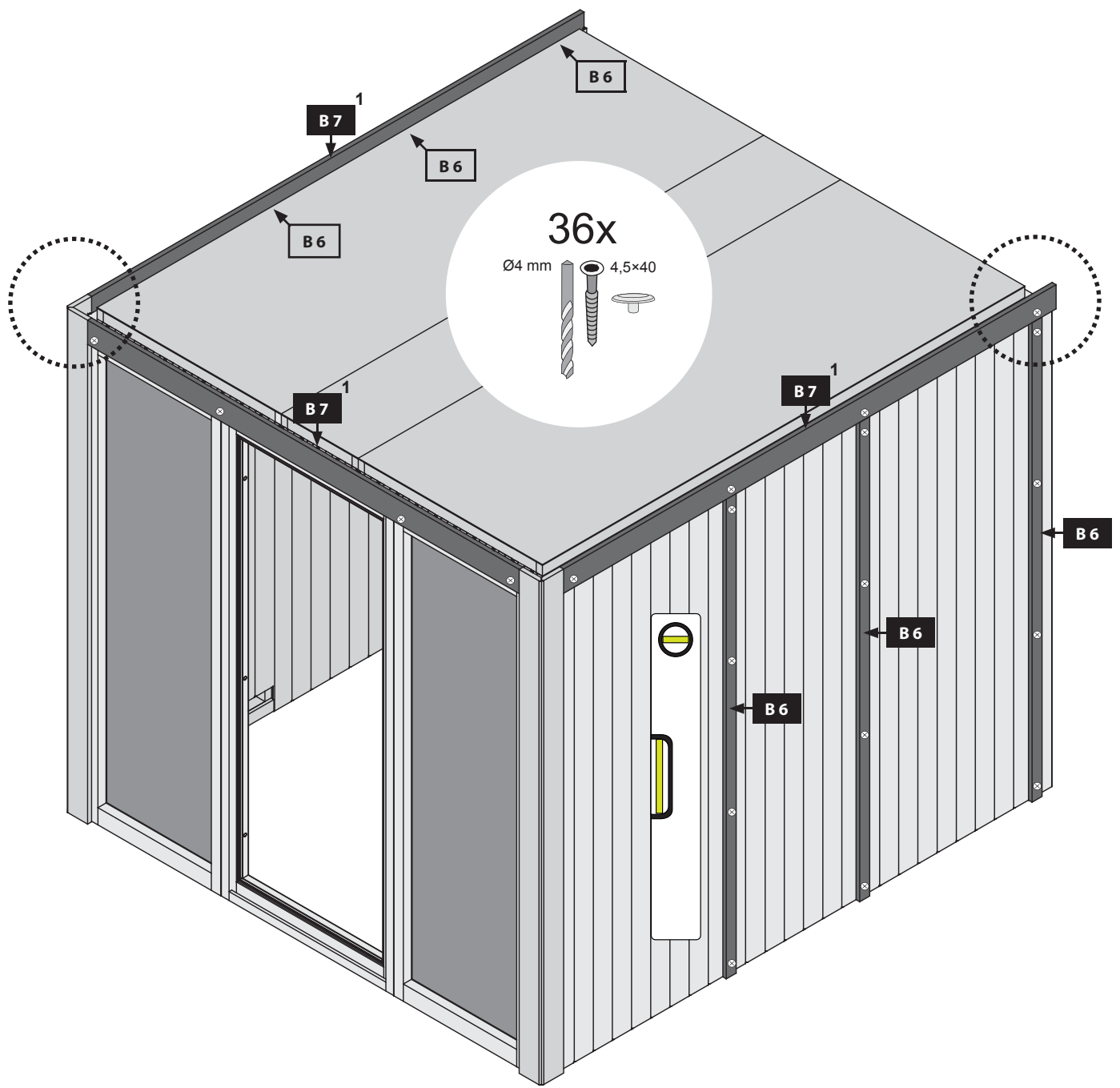
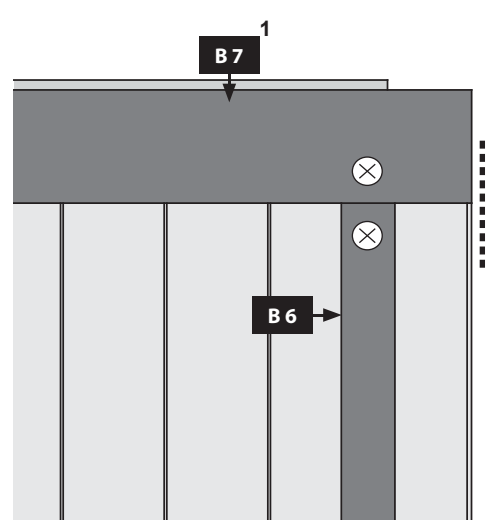
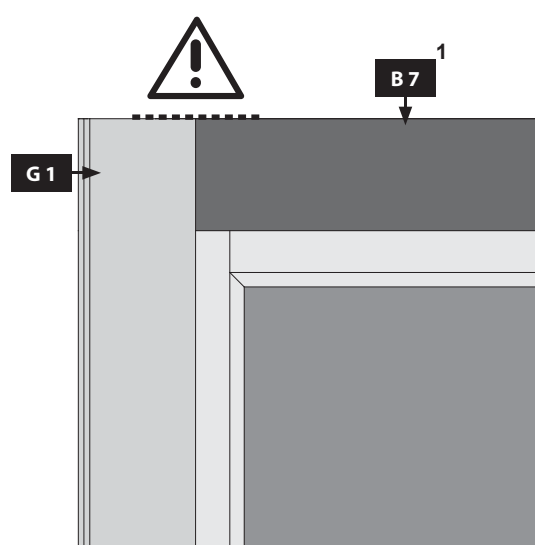

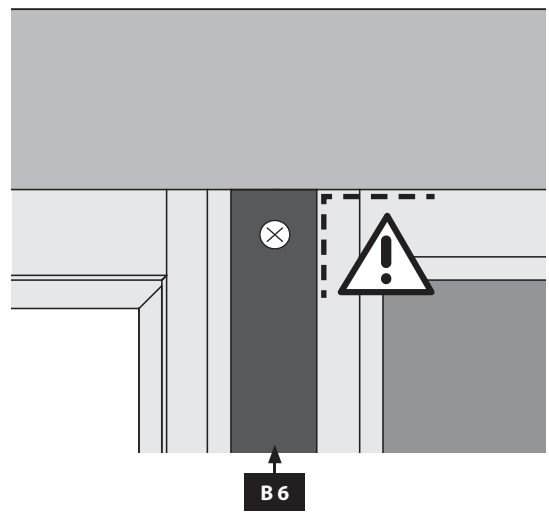
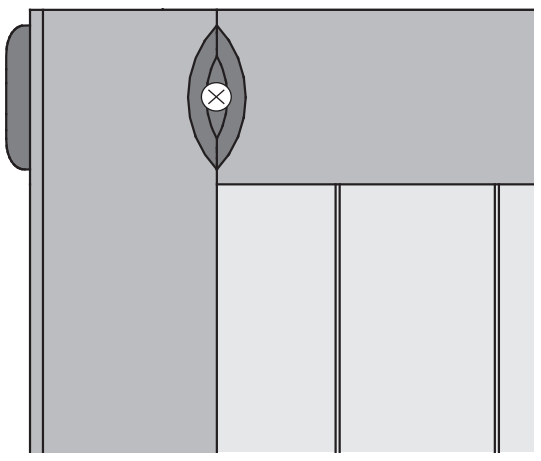
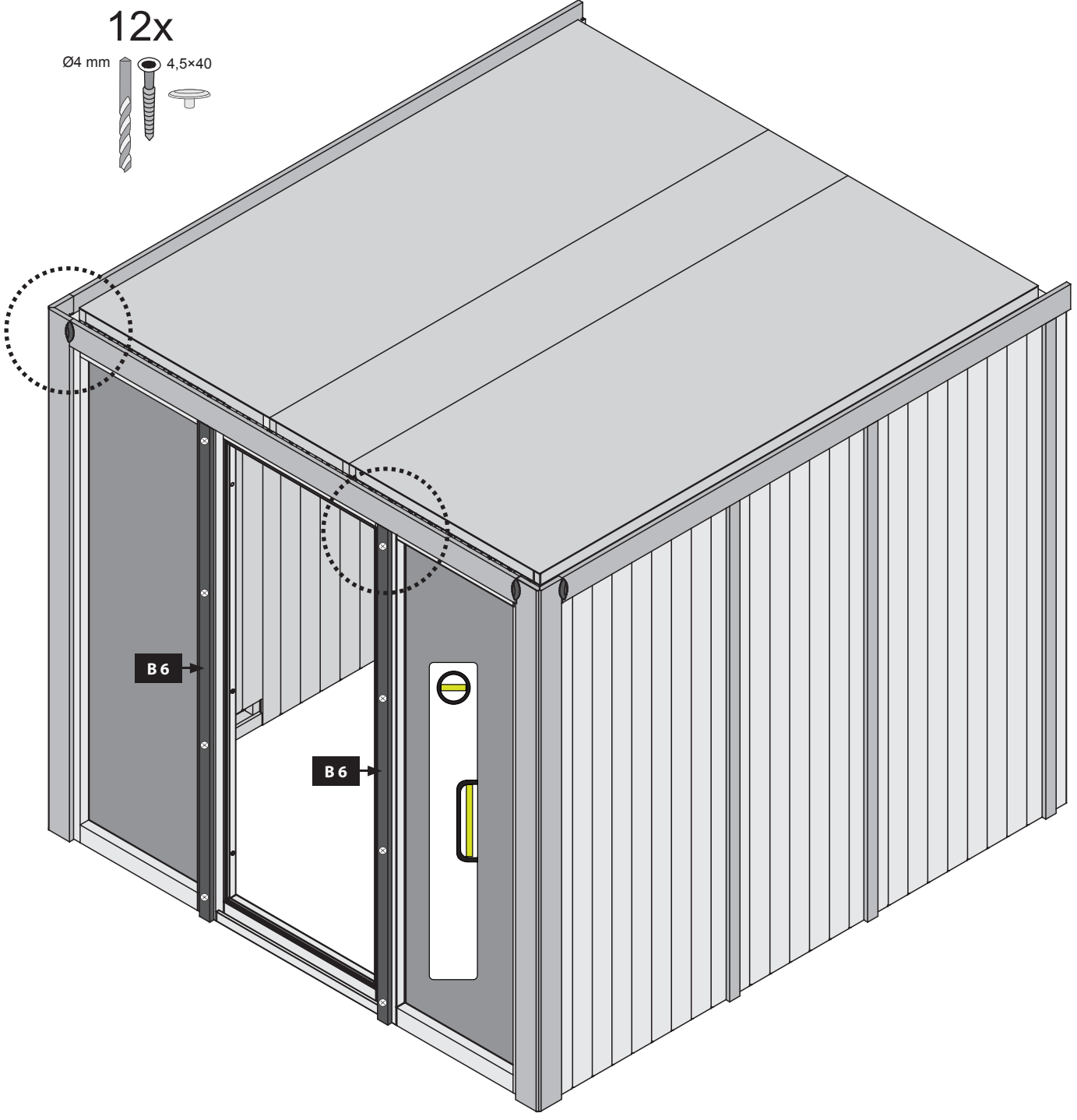
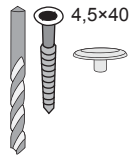

12x

Ø4 mm 4,5x40

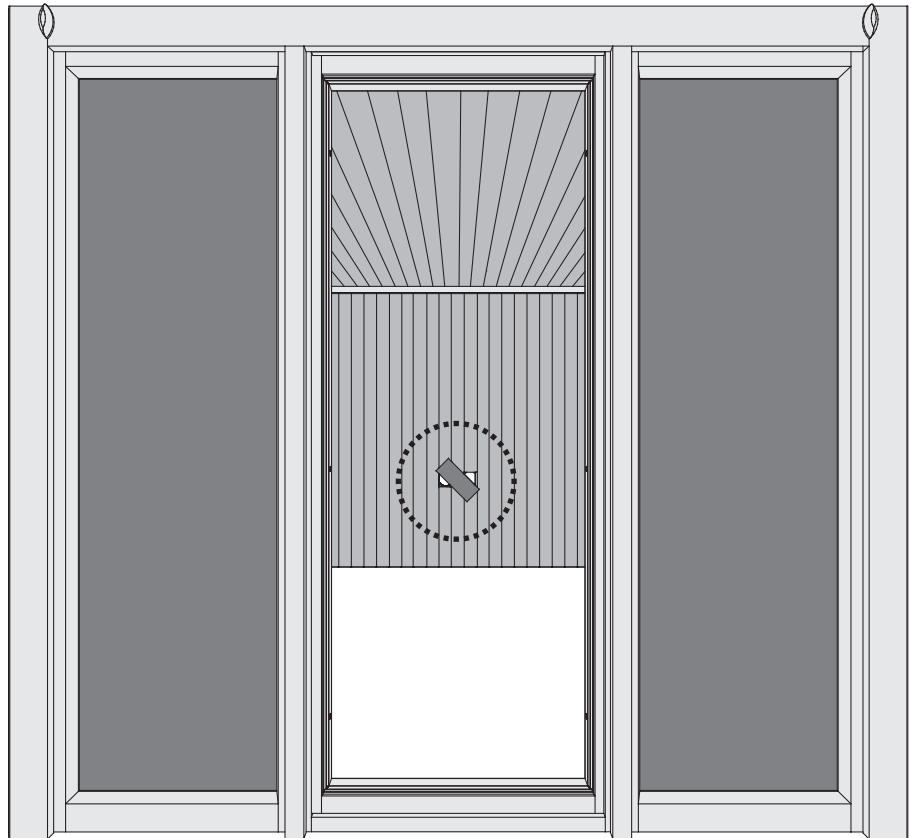
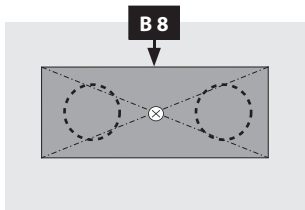
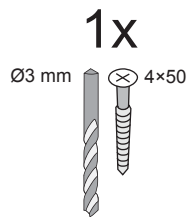





 Hier ist die Funktionsweise des Brettes abgebildet. Regeln Sie damit die Abluft nach Ihren eigenen Wünschen

 This figure shows the functional principle of the board. Regulate the exhaust air according to your own wishes

 Ceci représente le mode de fonctionnement de la planche. Avec elle, réglez l'écoulement de l'air selon vos désirs.

 Hier is de werking van het plankje afgebeeld. Regel daarmee de luchtafvoer naar eigen wens

 Sådán fungerer styret. Brug den til at regulere udstødningsluften efter dine egne ønsker

 Aquí está representada la forma de funcionamiento de la tabla. Regule con ello el aire de salida según sus propios deseos

 Viene illustrato il principio di funzionamento della tavoletta di regolazione della ventilazione. Con essa si può regolare a piacere la ventilazione

 Zde je zobrazená funkce desky. Regulujte s ní odsávací vzduch dle Vašeho přání

 Tukaj si lahko ogledate delovanje plošče. Z njo lahko uravnavate izpušni zrak po lastnih željah.

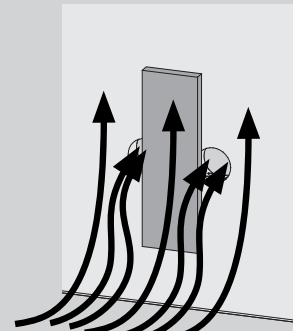
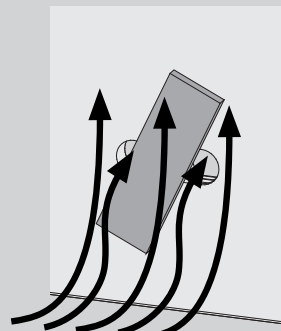
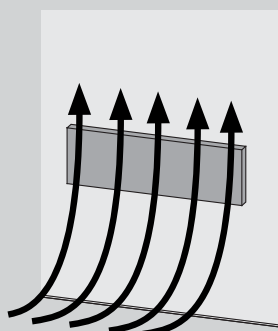

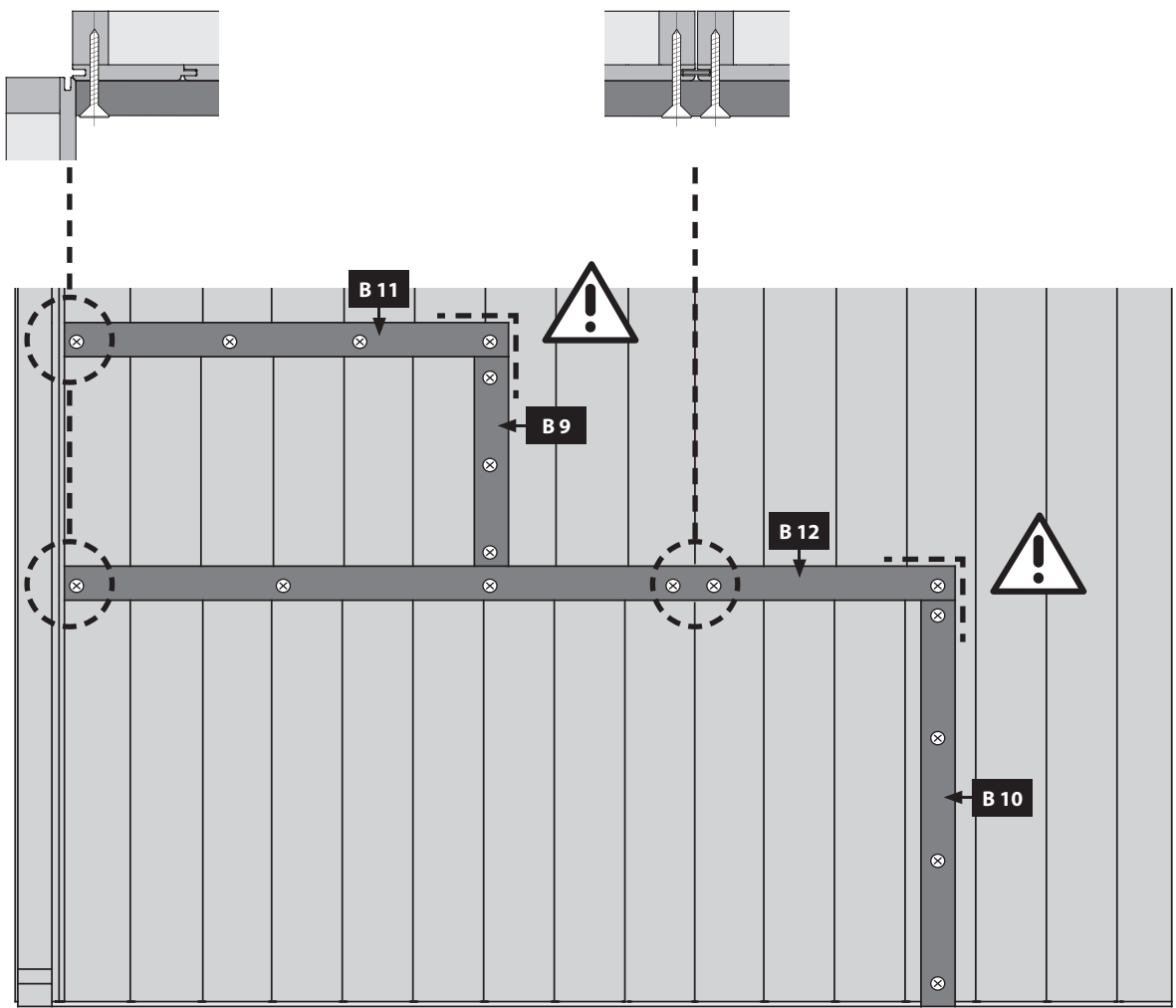
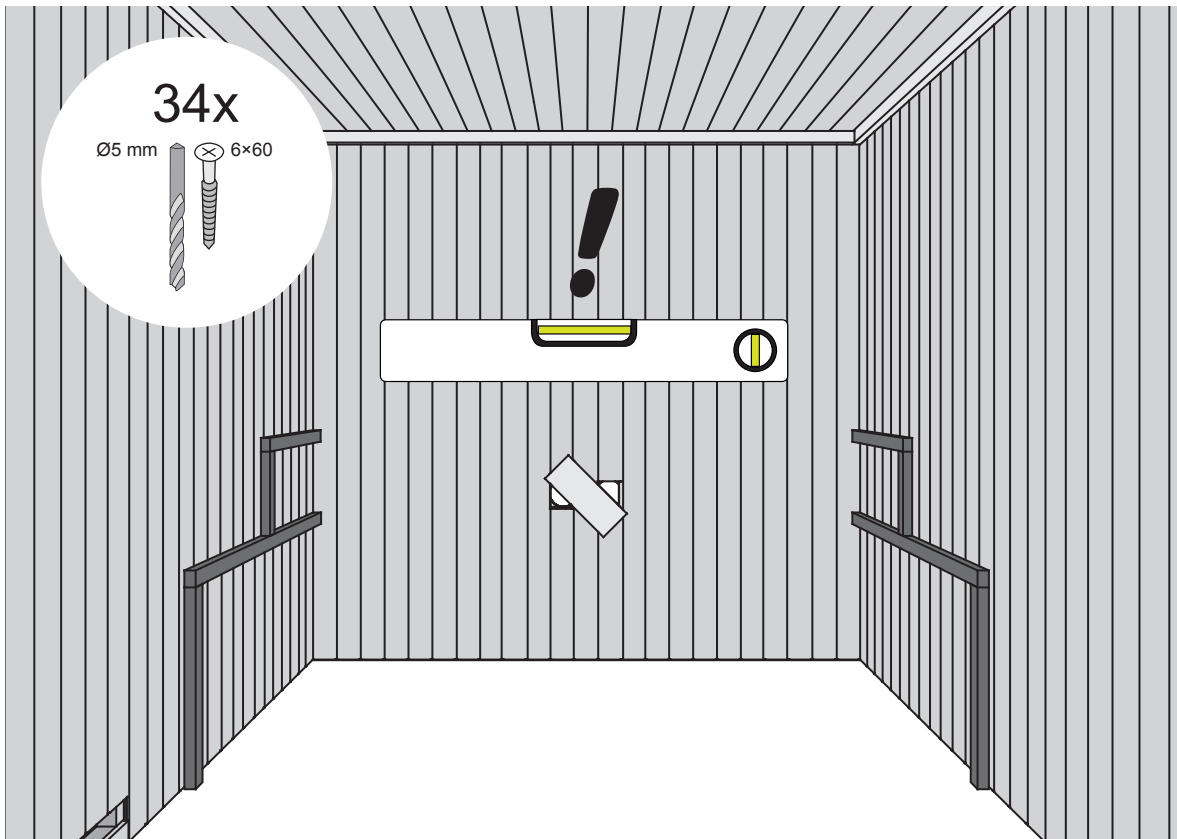

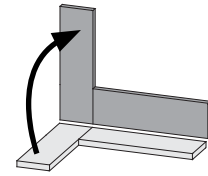
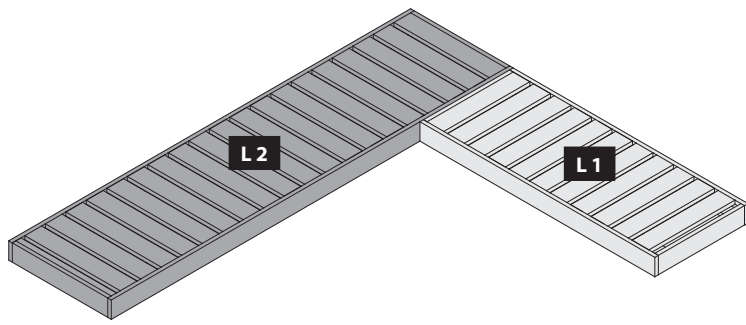

20

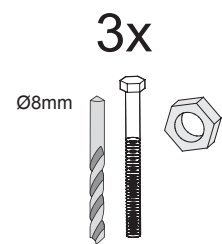
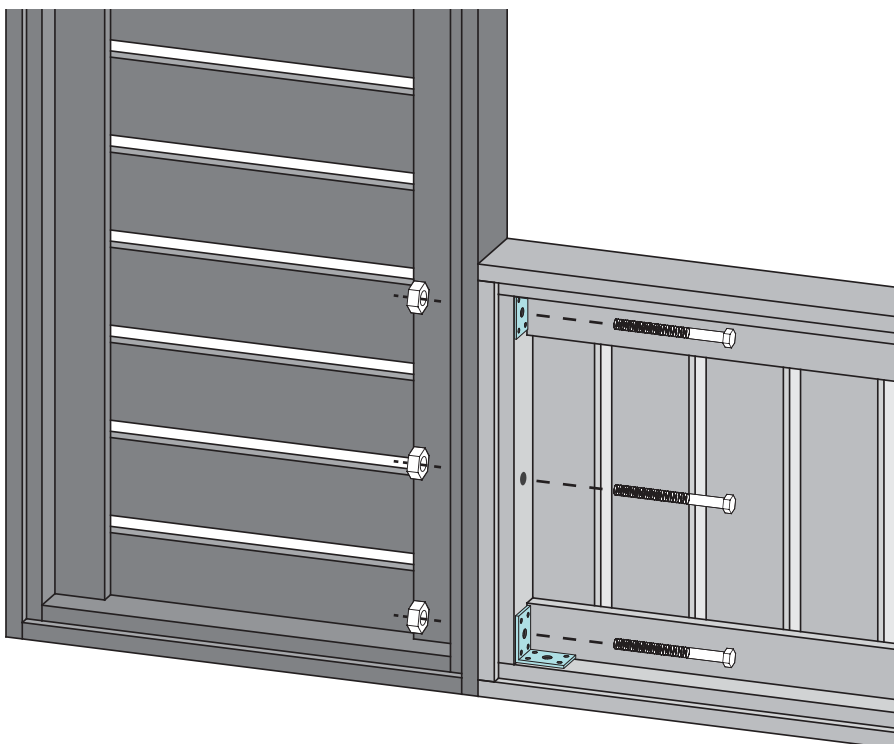
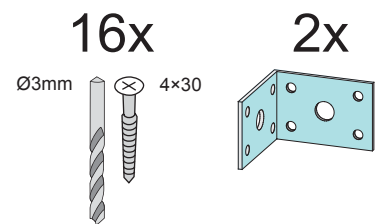
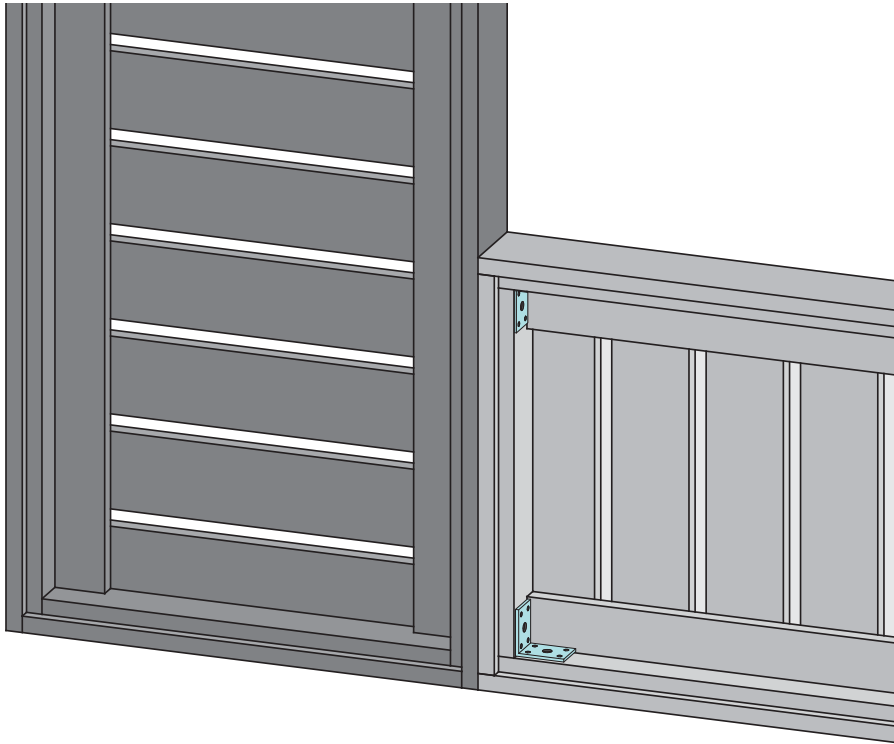



- Bündig!
- Flush!
- Affleurement!
- Gelijk!
- I flugt!
- Aras!
- Combacia!
- Stejný!
- Splakovanje!

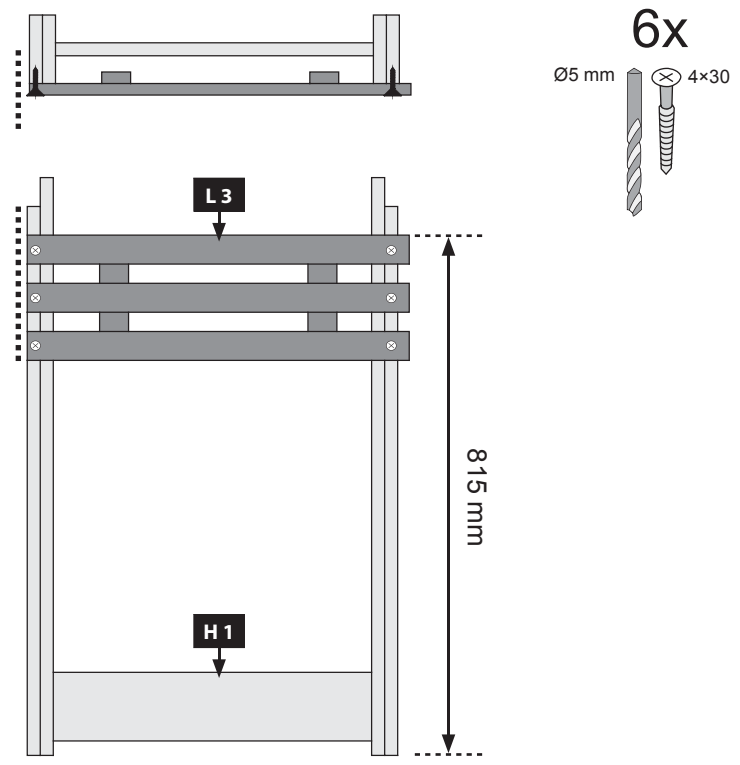

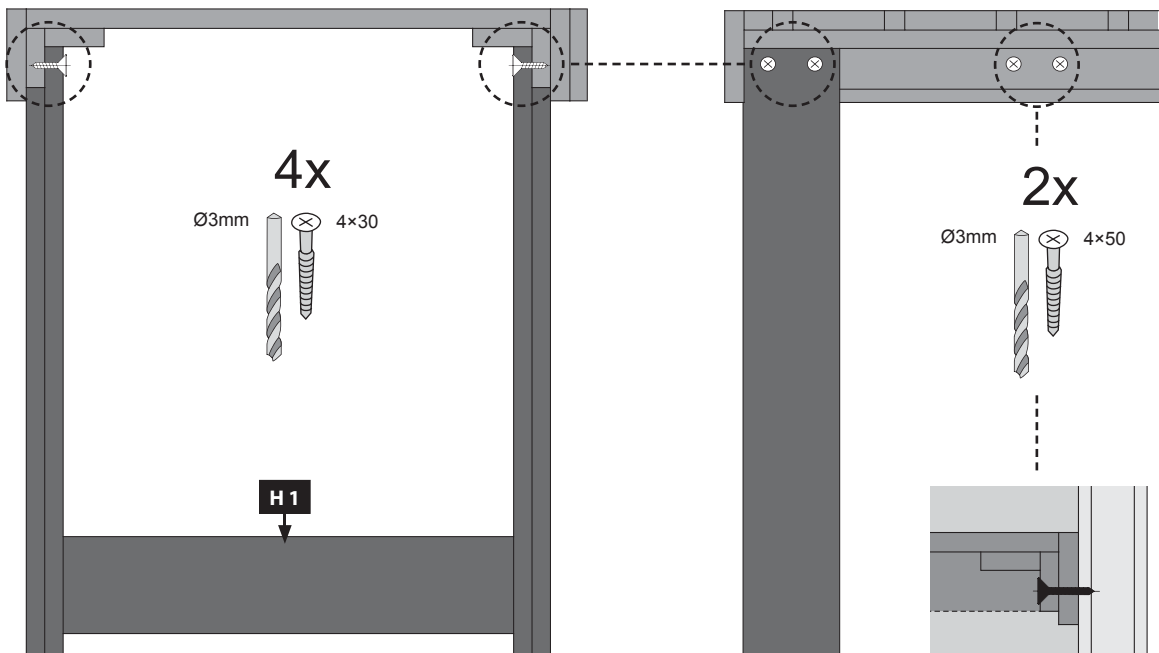
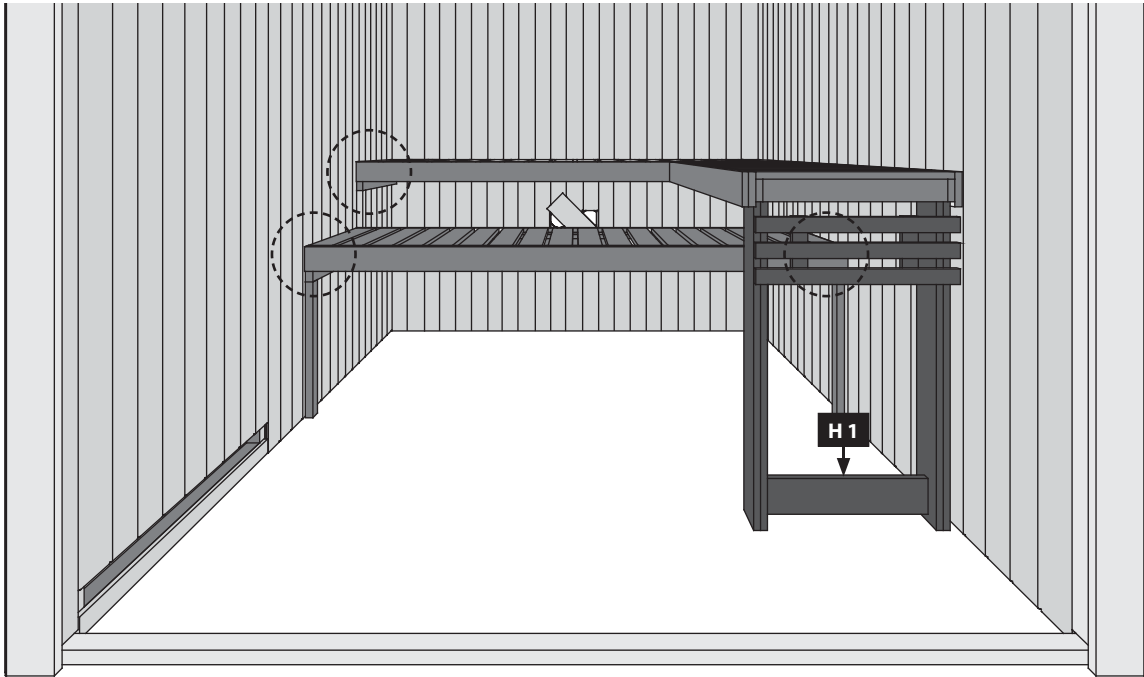
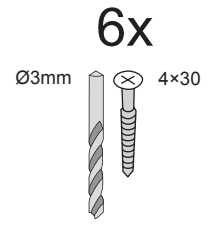
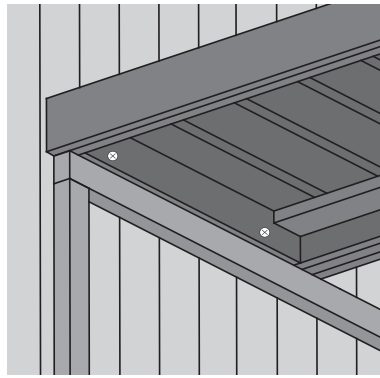
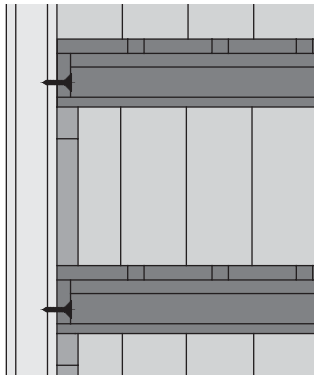

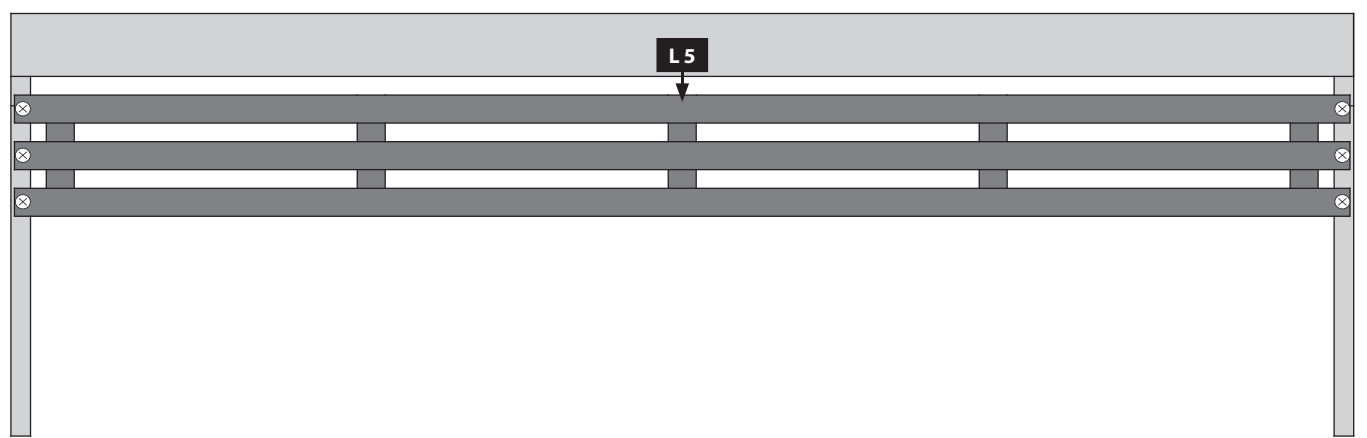
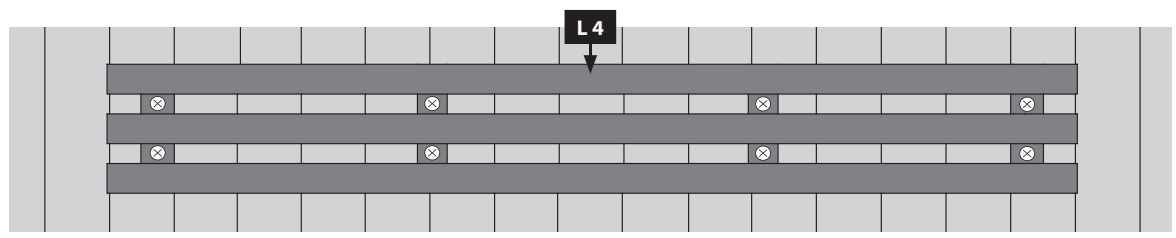
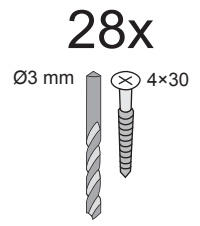
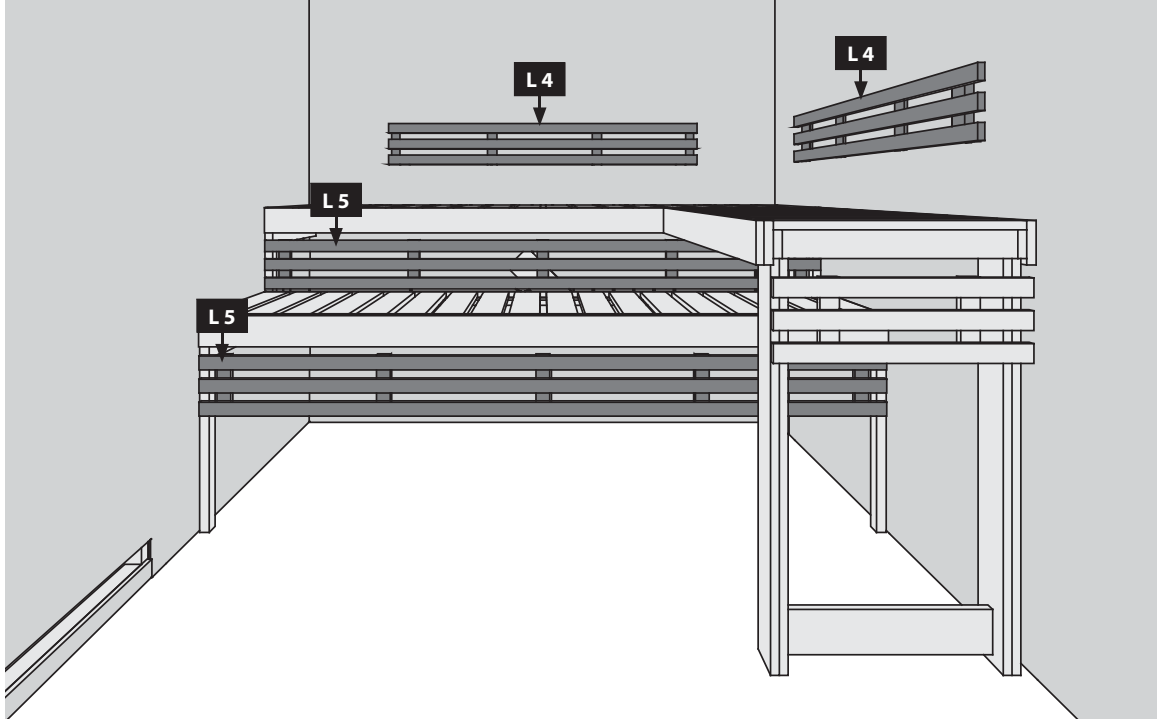

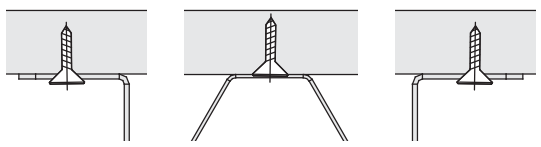
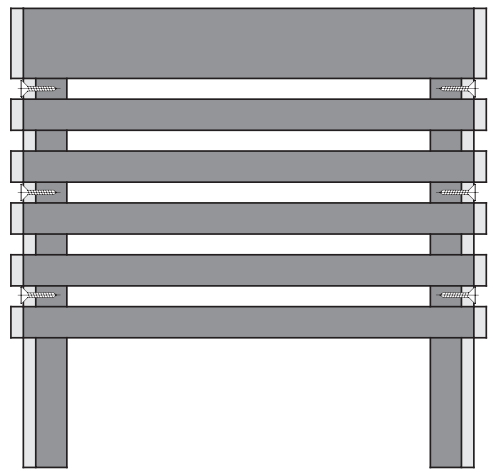
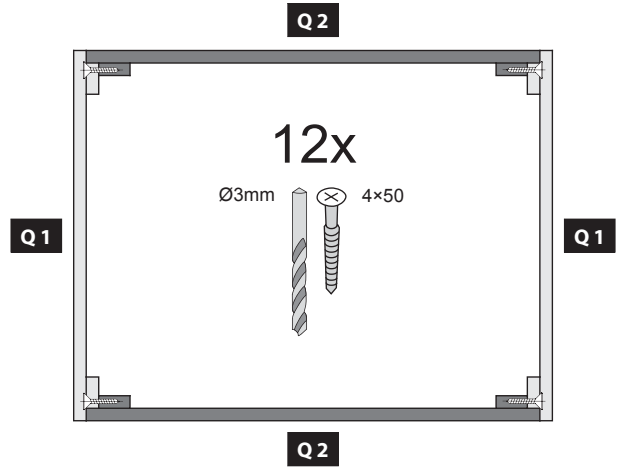
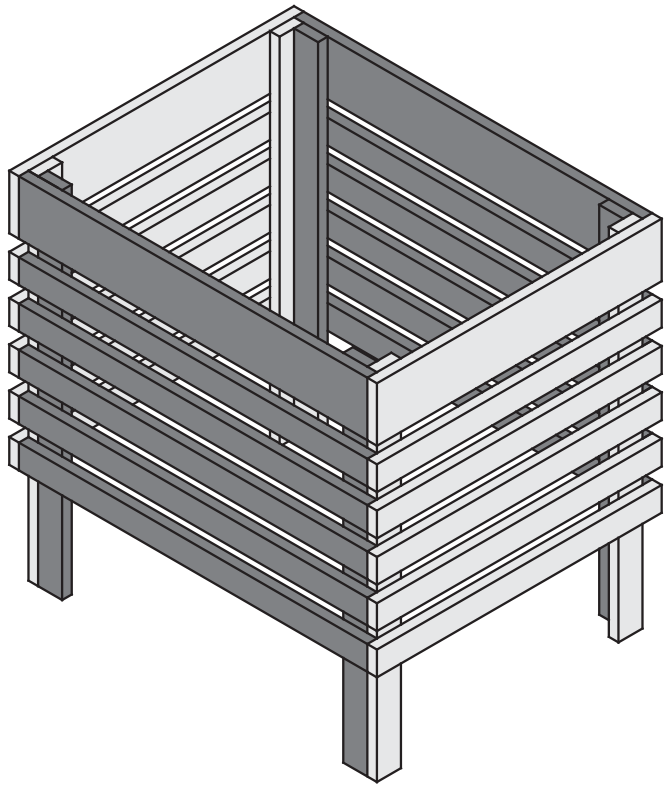



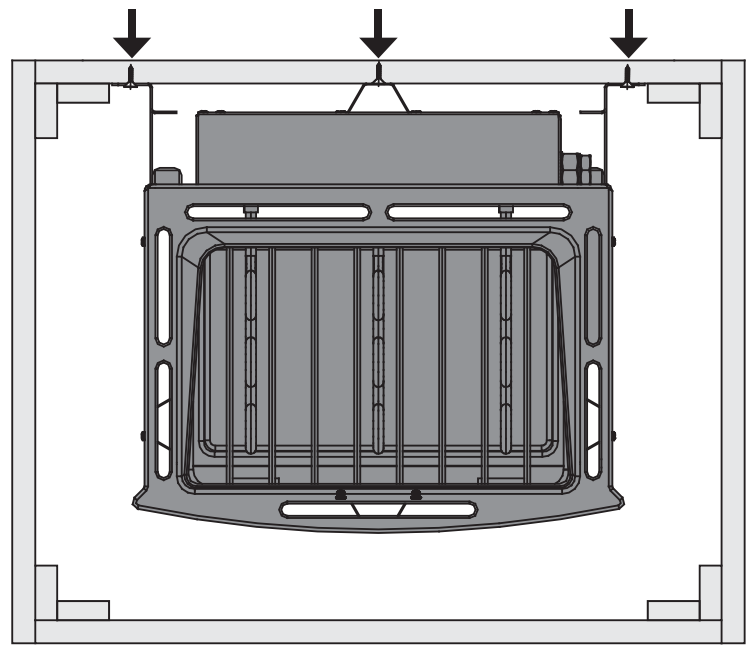

-  Ofenbefestigung
-  oven fixing
-  fixation four
-  oven vaststelling
-  ovn fastsættelse
-  fijación horno
-  fissaggio forno
-  upevňovací trouba
-  Montáža peči



 Kabeldurchführung

 implementatie voor de kabel

 implementazione per il cavo

 implementation for the cable

 Kabelforskruning

 provedení kabelu

 mise en œuvre pour le câble

 implementación para el cable

 Kabelsko žrelo

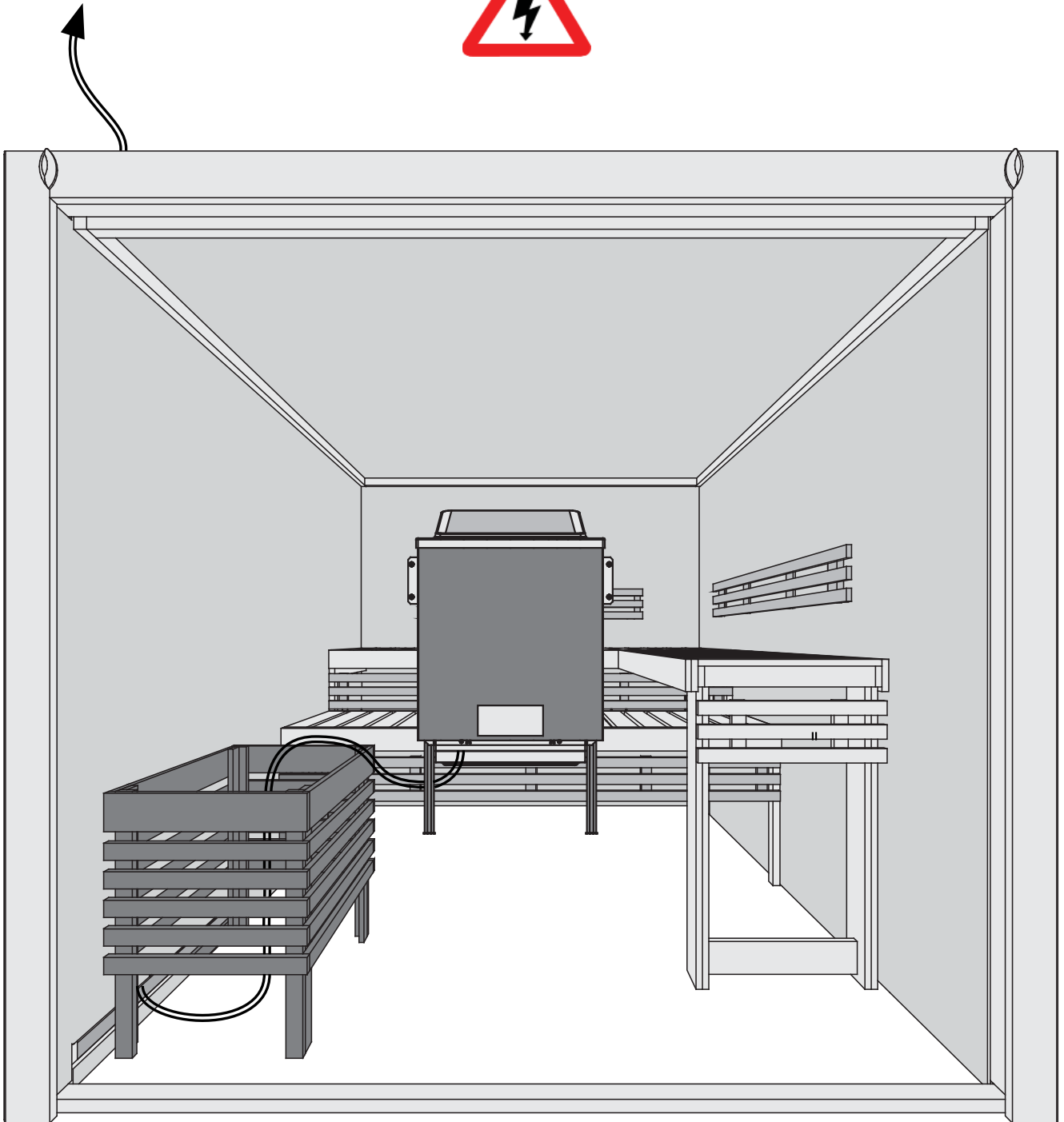



 Exemplarische Kabelverlegung

 Voorbeeld van het leggen van kabels

 Esempi di posa di cavi

 Exemplary cable laying

 Eksempel på kabellægning

 Příkladné pokládání kabelů

 Exemple de pose de câbles

 Tendido de cables ejemplar

 Vzorčno polaganje kablov

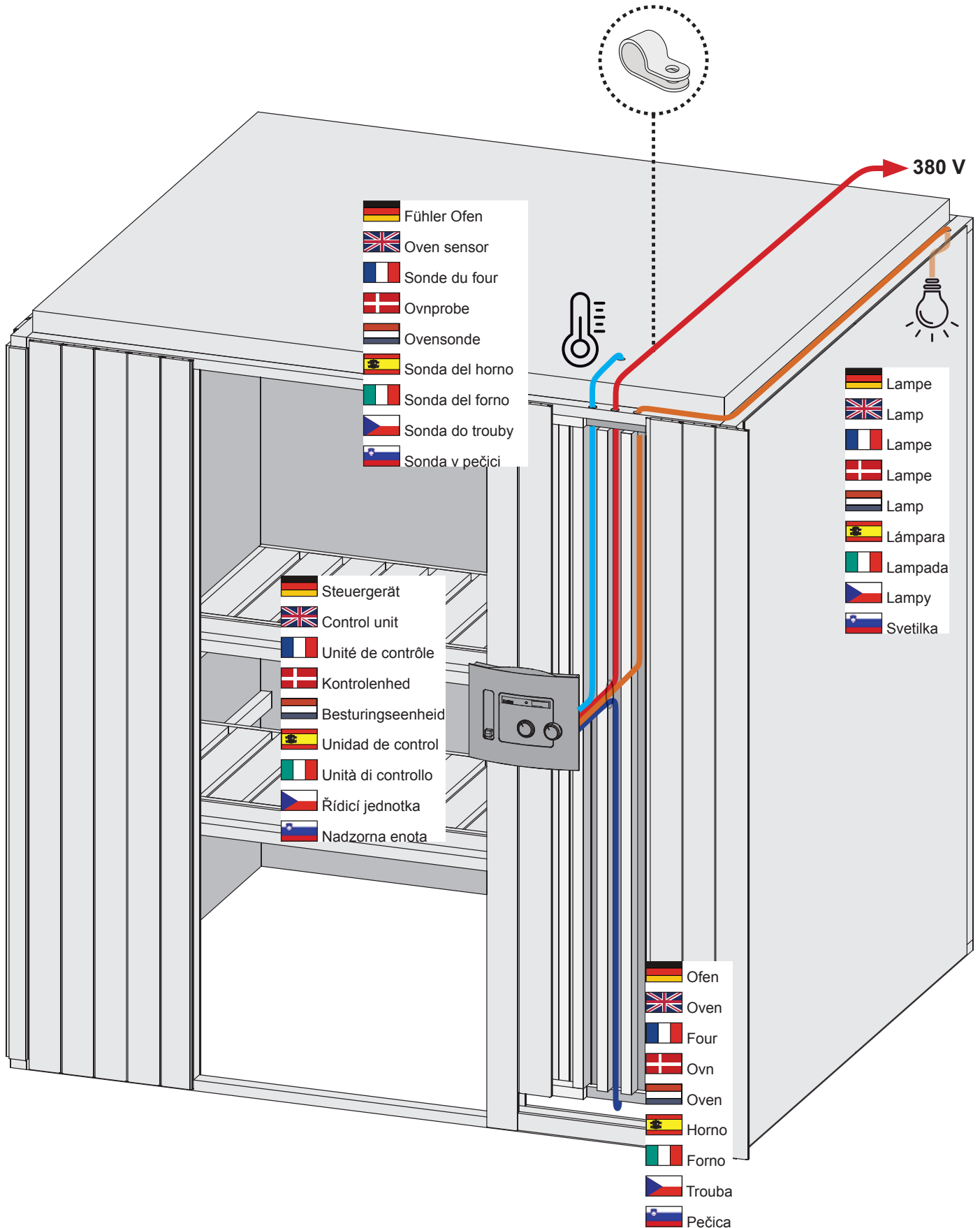
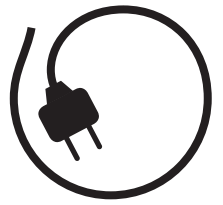



 Exemplarische Kabelverlegung

 Voorbeeld van het leggen van kabels

 Esempi di posa di cavi

 Exemplary cable laying

 Eksempel på kabellægning

 Příkladné pokládání kabelů

 Exemple de pose de câbles

 Tendido de cables ejemplar

 Vzorčno polaganje kablov

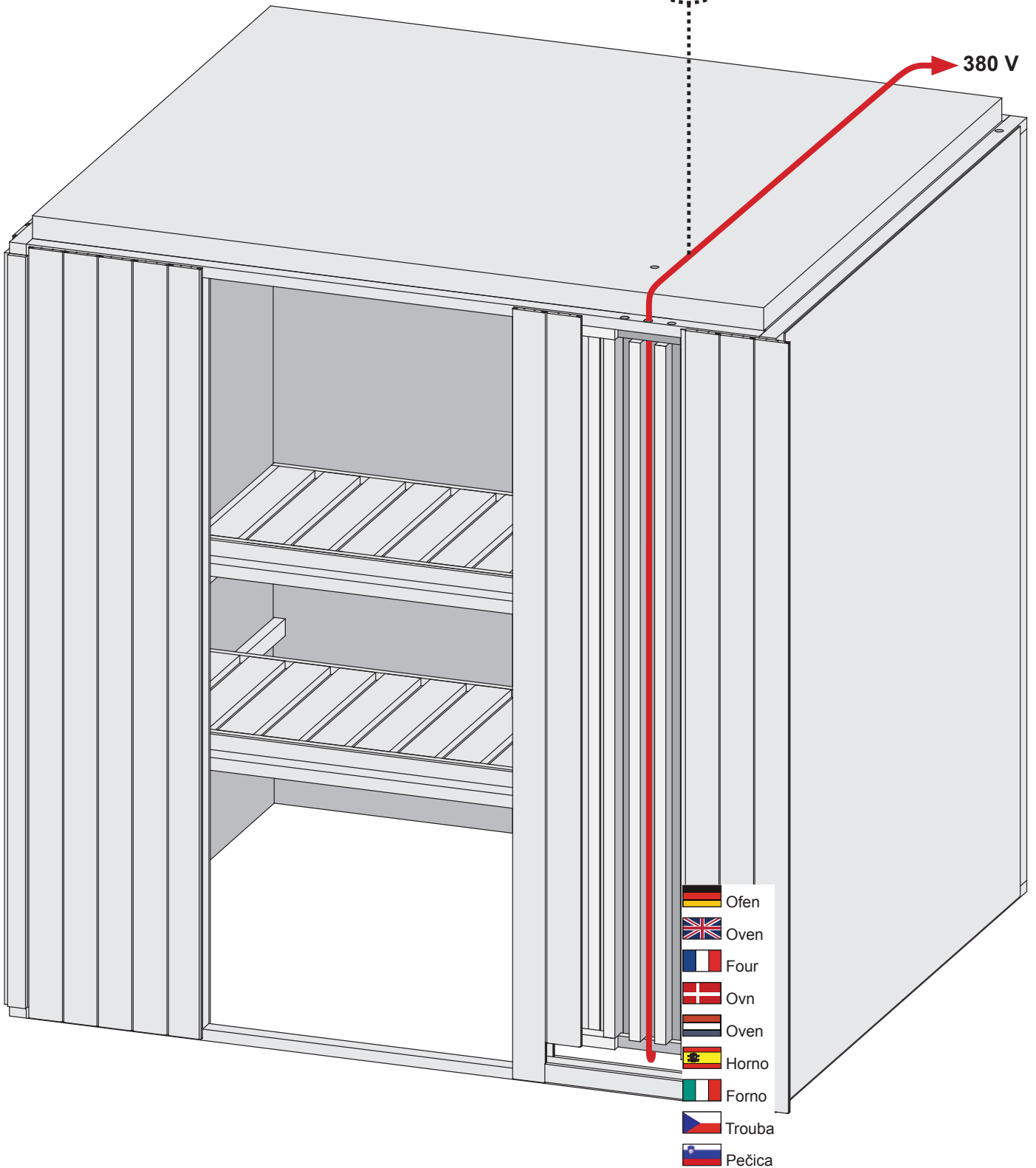
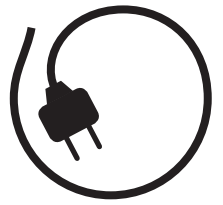

 Einbau Tür

 Installatie deur

 Porta di installazione

 Installation door

 Installationsdør

 Montážní dveře

 Porte d'installation

 Puerta de instalación

 Vgradna vrata

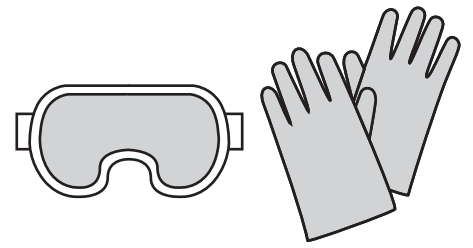

28

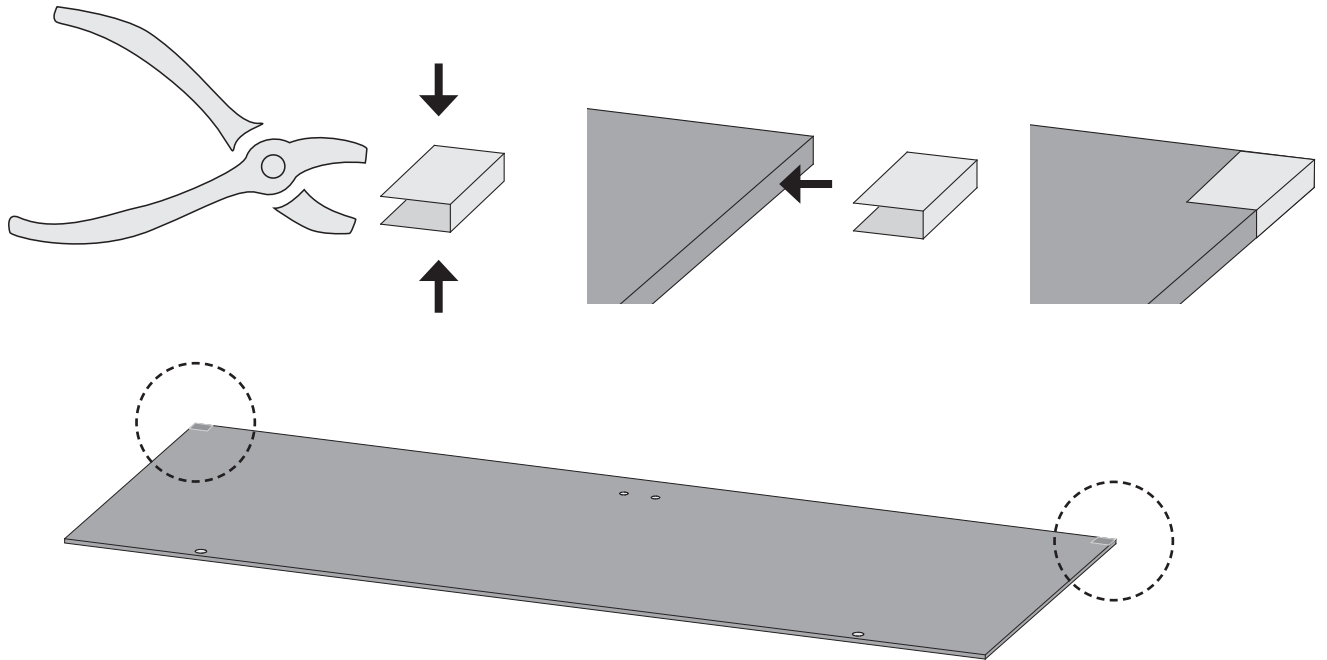

29

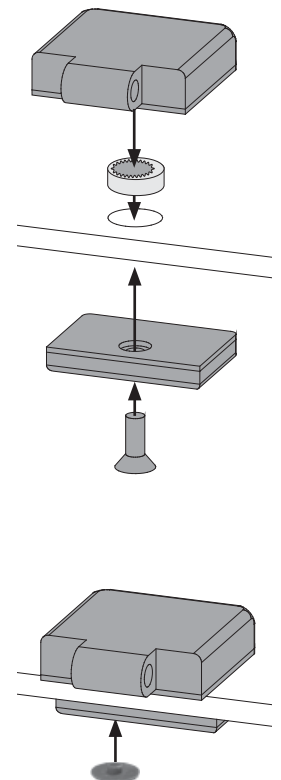
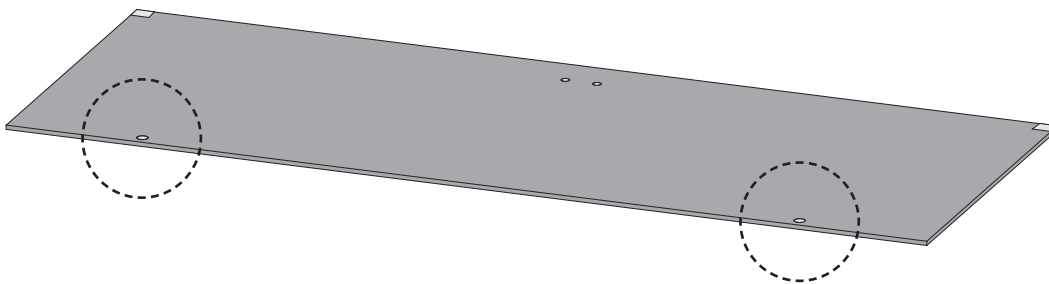



 Alle Verstell-Excenter müssen in der Glasscheibe die gleiche Grundstellung haben

 All adjustable eccentrics must have the same basic adjustment in the glass panel

 Tous les excentreurs de positionnement doivent avoir la même position de base dans la vitre

 Alle excentrische verstelelementen moeten in dezelfde stand in de glasplaat worden geplaatst

 Alle justeringsexcenter skal have samme grundlæggende position i glasruden

 Todos los excéntricos regulables tienen que tener la misma posición base en la hoja de cristal



 Tutti gli eccentrici di regolazione devono avere la stessa posizione base nella lastra di vetro

 šechny nastavovací podivínů musí mít stejný základní polohy ve skle

 Vsi nastavitveni ekscentri morajo imeti enak osnovni položaj v steklu.

 Einbau Tür
 Installation door
 Porte d'installation

 Installatie deur
 Installationsdør
 Puerta de instalación

 Porta di installazione
 Montážní dveře
 Vgradna vrata

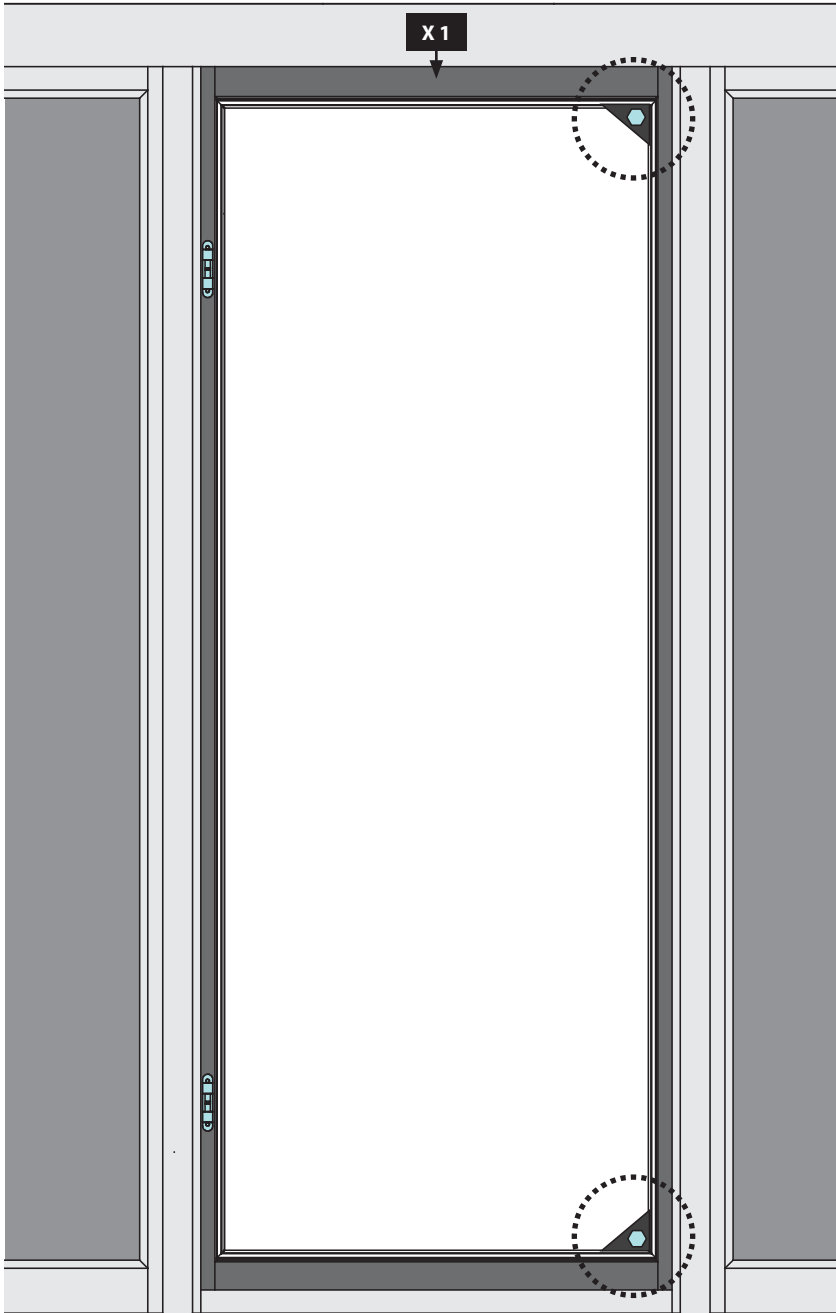
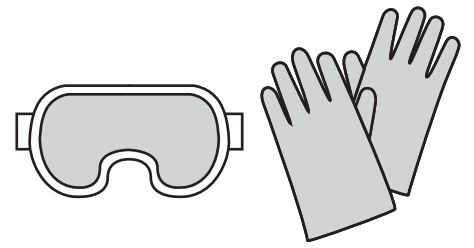

 Einbau Tür

 Installatie deur

 Porta di installazione

 Installation door

 Installationsdør

 Montážní dveře

 Porte d'installation

 Puerta de instalación

 Vgradna vrata

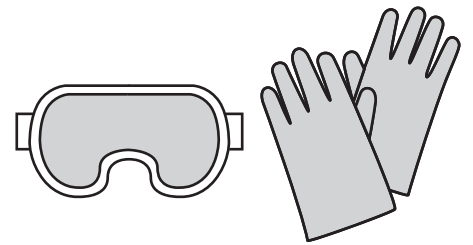



31

 Alle Verstell-Excenter müssen in der Glasscheibe die gleiche Grundstellung haben

 All adjustable eccentrics must have the same basic adjustment in the glass panel

 Tous les excentreurs de positionnement doivent avoir la même position de base dans la vitre

 Alle excentrische verstelelementen moeten in dezelfde stand in de glasplaat worden geplaatst

 Alle justeringsexcentricer skal have samme grundlæggende position i glasruden

 Todos los excéntricos regulables tienen que tener la misma posición base en la hoja de cristal

 Tutti gli eccentrici di regolazione devono avere la stessa posizione base nella lastra di vetro

 šechny nastavovací podivínů musí mít stejný základní polohy ve skle

 Vsi nastavitveni ekscentri morajo imeti enak osnovni položaj v steklu.

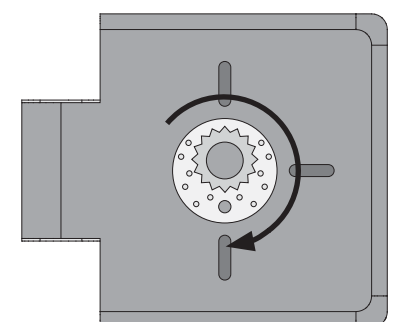
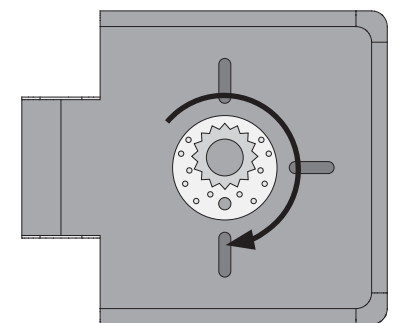
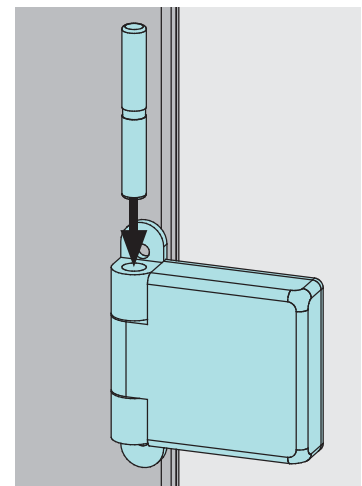
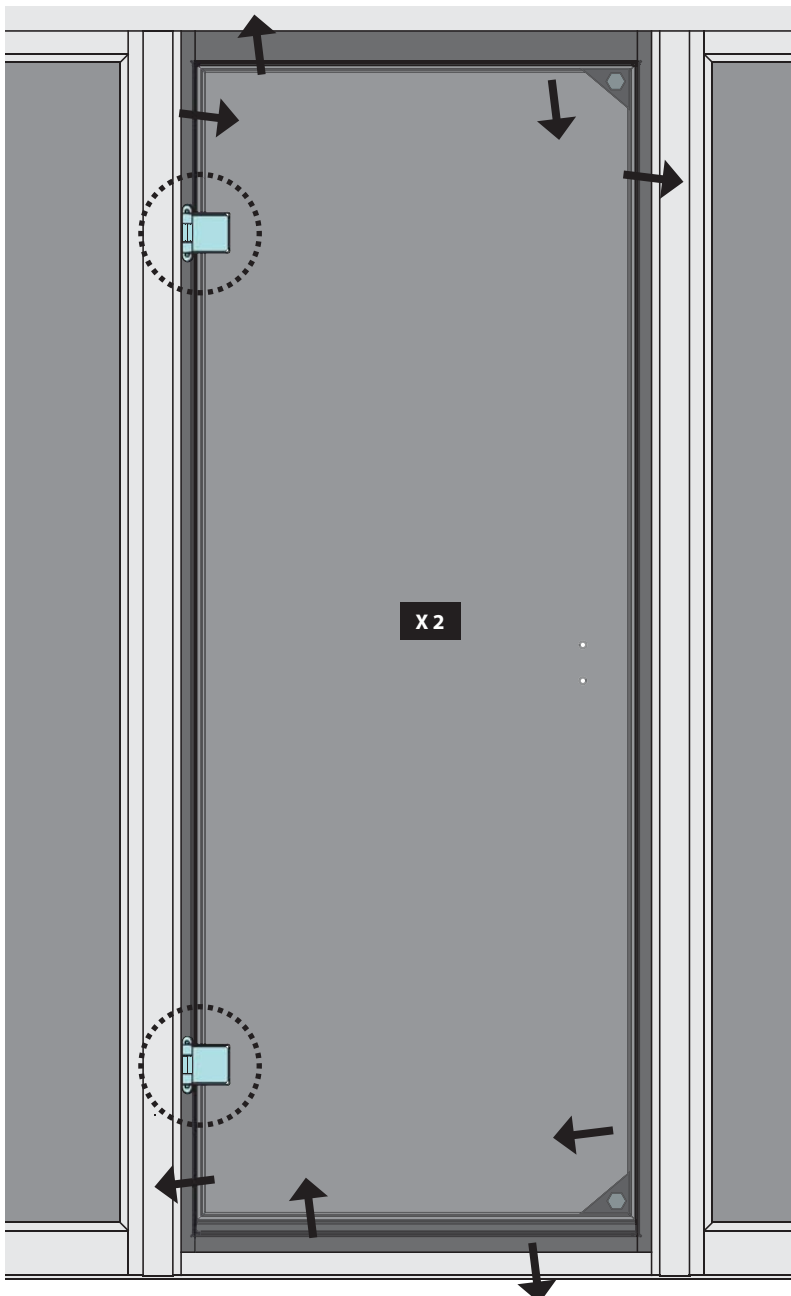

1.

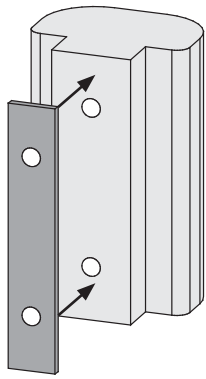

2.

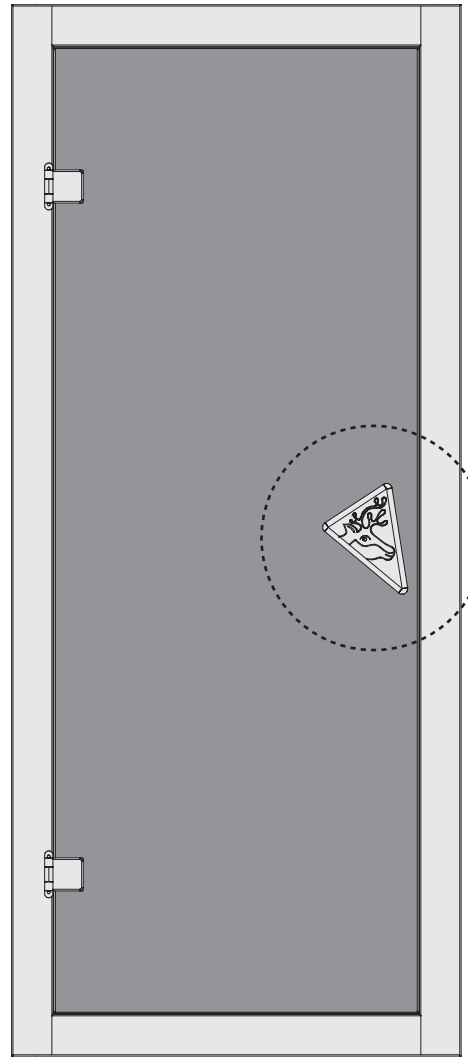
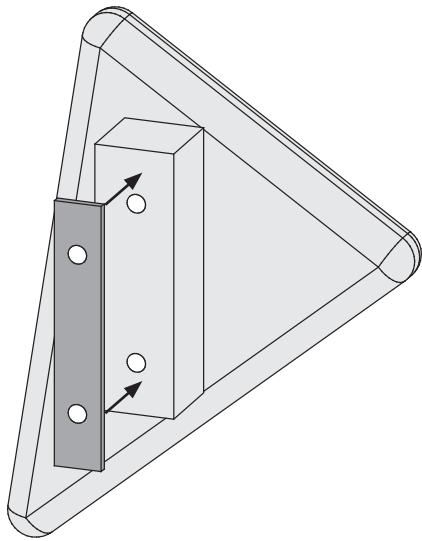

3.

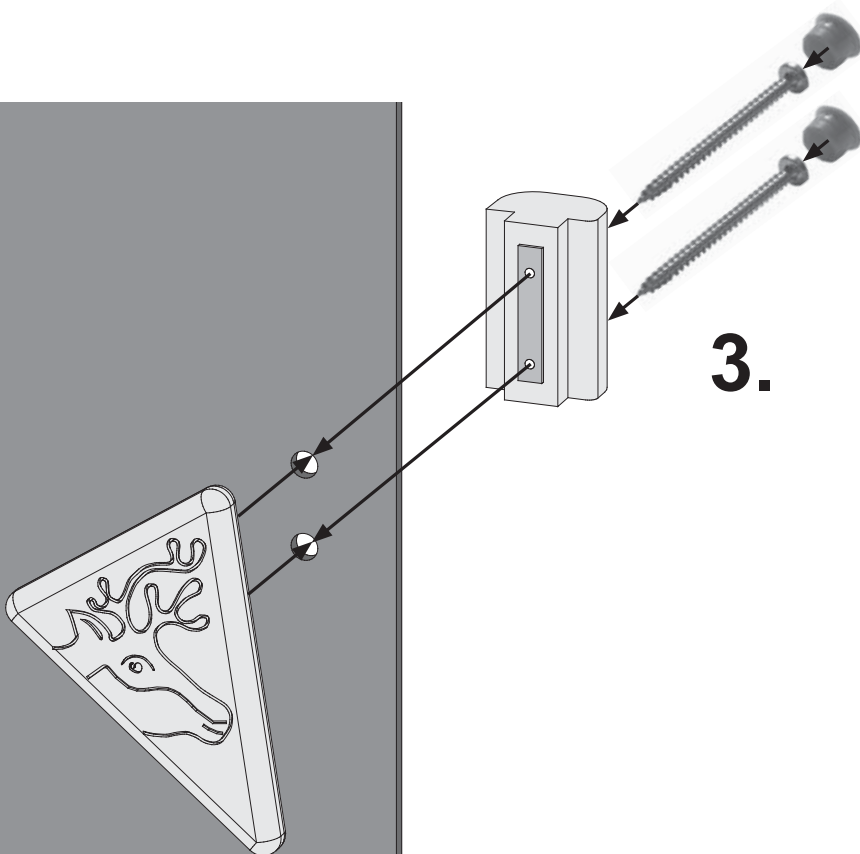

47372

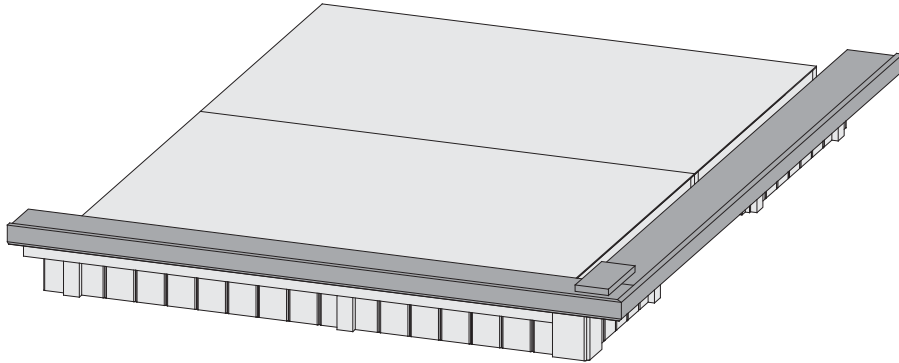

 **Aufbauanleitung**

 **Building Instructions**

 **notice de montage**

 **montagehandleiding**

 **Montagevejledning**

 **Instrucciones de construcción**

 **Istruzioni per il montaggio**

 **Montážní návod**

 **Navodila za sestavljanje**

 Vergleichen Sie zuerst die Material-liste mit Ihrem Paketinhalt! Bitte haben Sie Verständnis, dass Beanstandungen nur im nicht aufgebauten Zustand bearbeitet werden können!

 First compare the list of materials with your package contents! Please understand that complaints can be processed in the non-built status only!

 Commencez par comparer la liste du matériel avec le contenu de votre paquet! Sachez que nous traitons uniquement les réclamations concernant le matériel à l'état non monté!

 Vergelijk eerst de lijst van materialen met de inhoud van uw pakket! Reclamaties kunnen alleen in behandeling worden genomen zolang de onderdelen nog niet zijn gemonteerd!

 Start med at kontrollere materialelisten med indholdet af den leverede pakke! Vi gør venligst opmærksom på at reklamationer kun kan behandles for materialer som ikke er blevet bearbejdet!

 En primer lugar, compare la lista de material con el contenido del paquete. Rogamos entienda que las reclamaciones sólo pueden ser tramitadas antes de montar el objeto!

 Confrontate questa distinta materiali prima con il contenuto del pacchetto! Vi preghiamo di comprendere che eventuali reclami possono essere accolti solo prima del montaggio!

 Nejprve přezkontrolujte obsah balení podle materiálového listu! Mějte pochopení pro to, že případnou reklamaci se můžeme zabývat pouze tehdy, když díly nebudou smontované! Za pomoci tohoto seznamu můžete jednotlivé díly přiřadit k montážnímu návodu.

 Najprej primerajte zoznam materialov z vsebino vašega paketa! Upoštevajte, da lahko pritožbe obravnavamo le v nesestavljenem stanju!

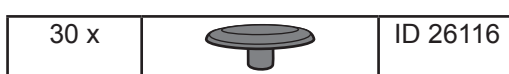
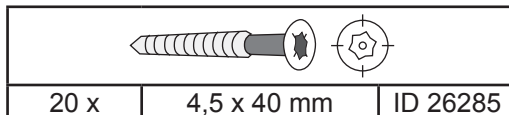
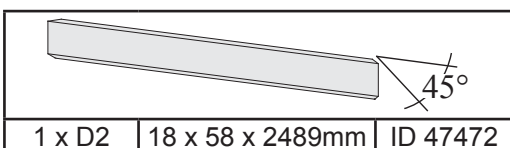
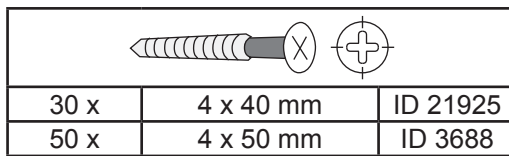
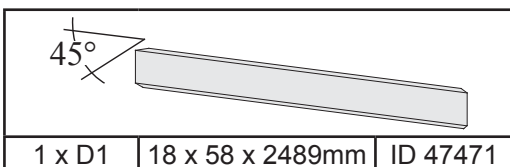
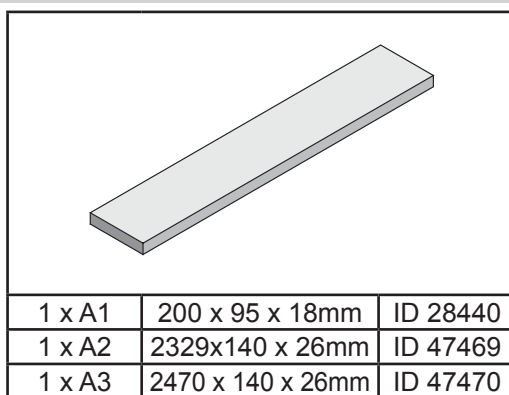
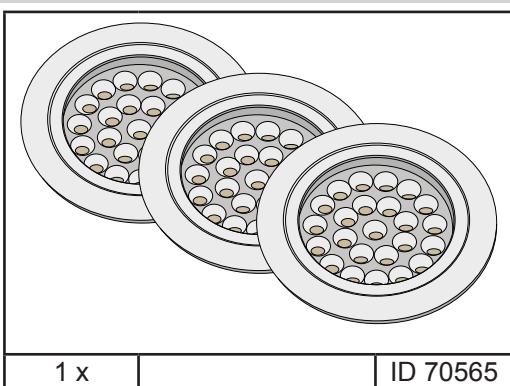
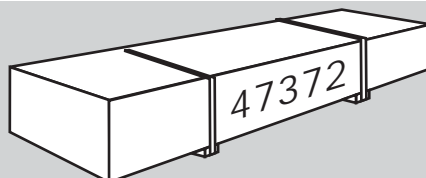

01

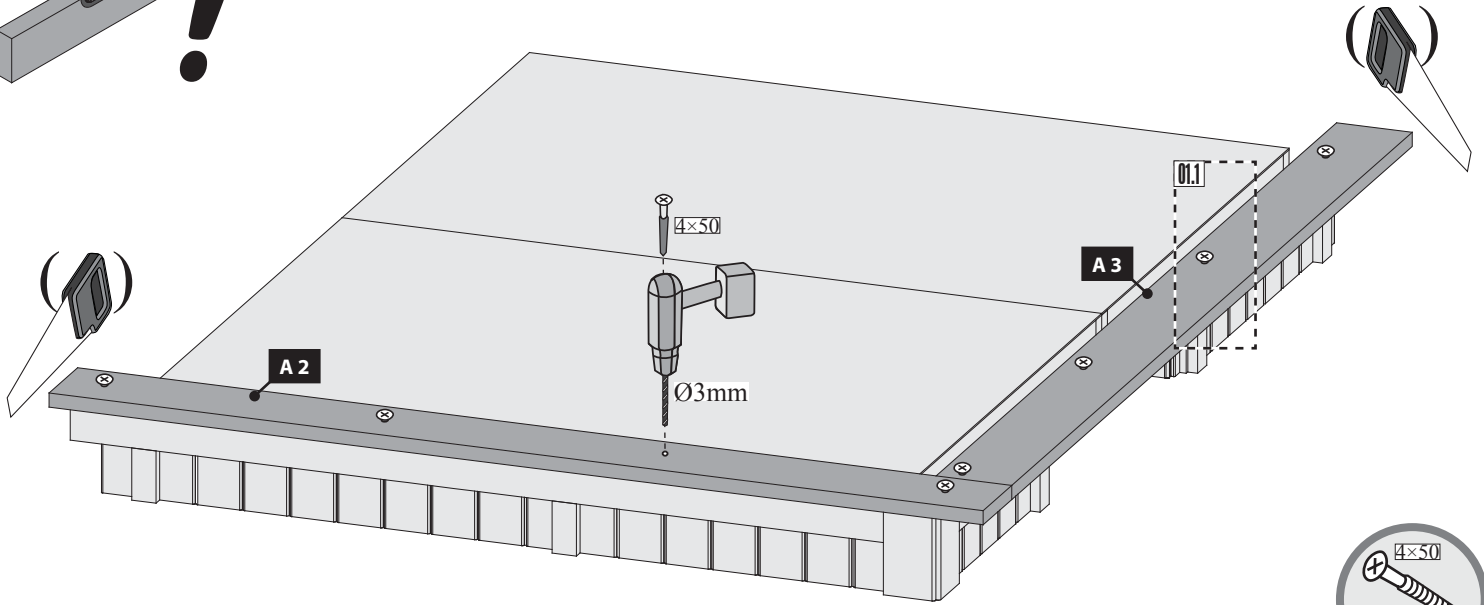
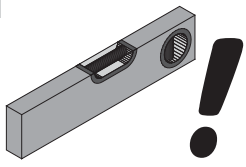

01.1

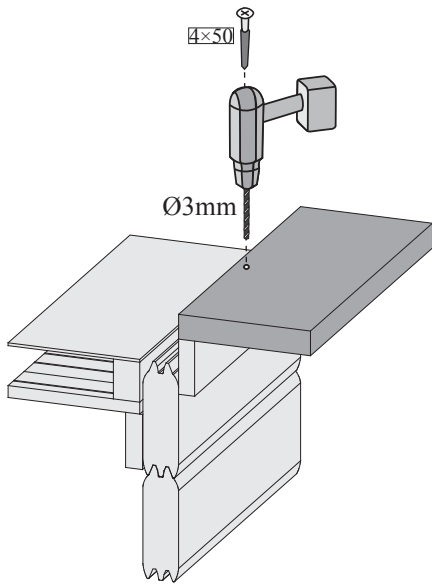

02.1

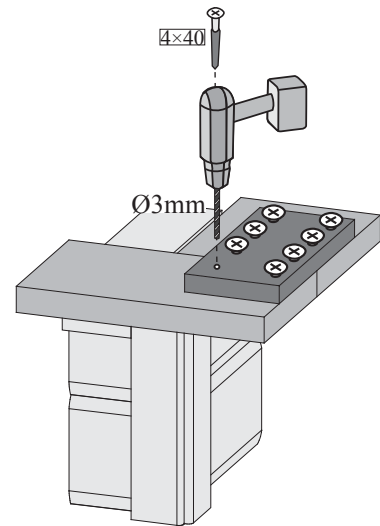

02

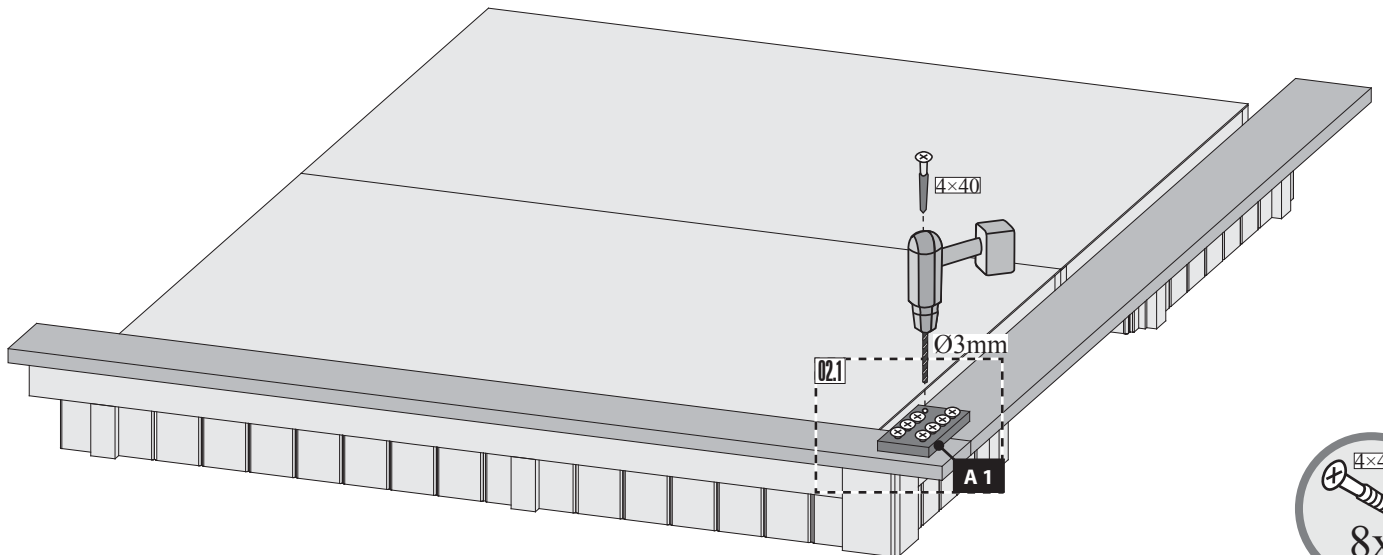

03

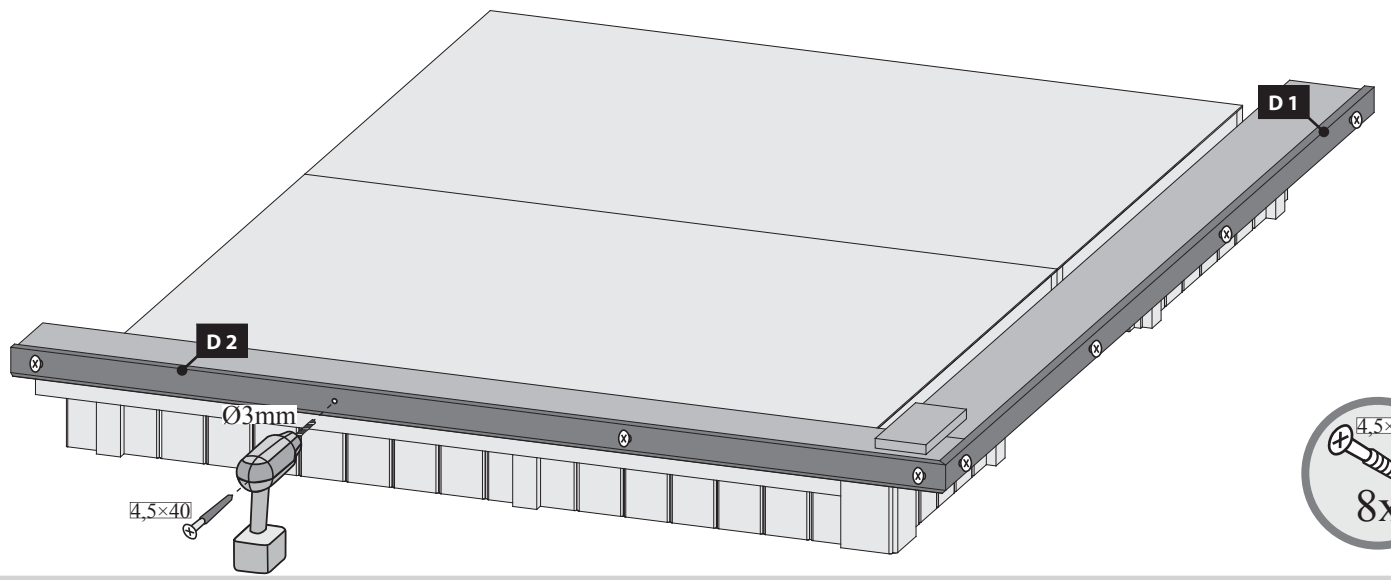

04

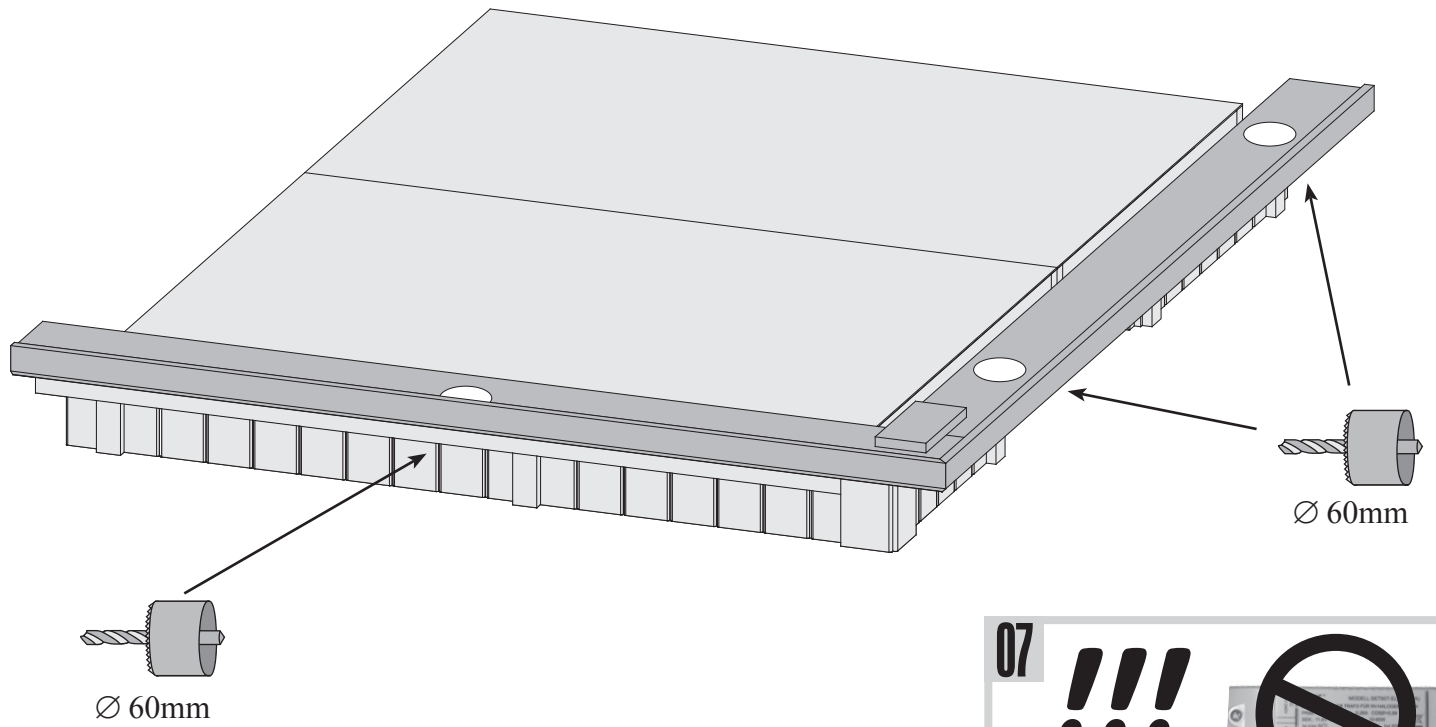

05

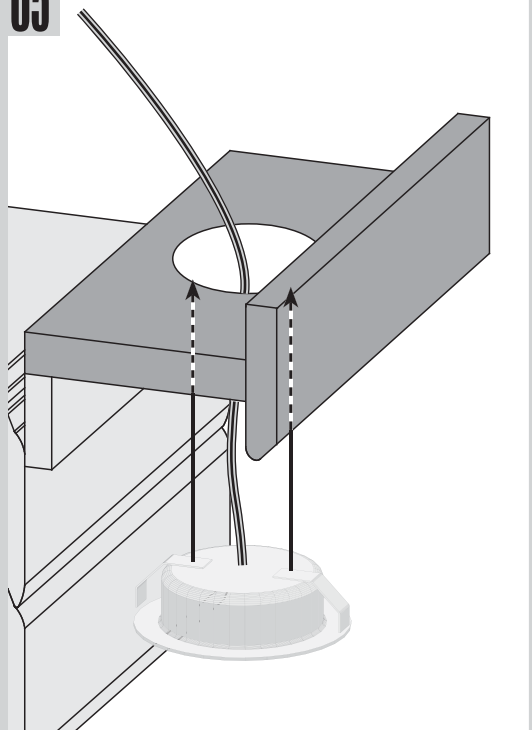

06

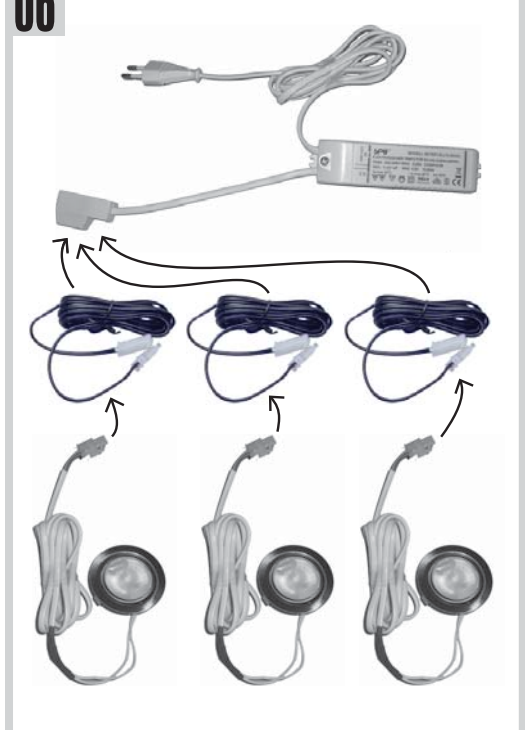

07

