

2251

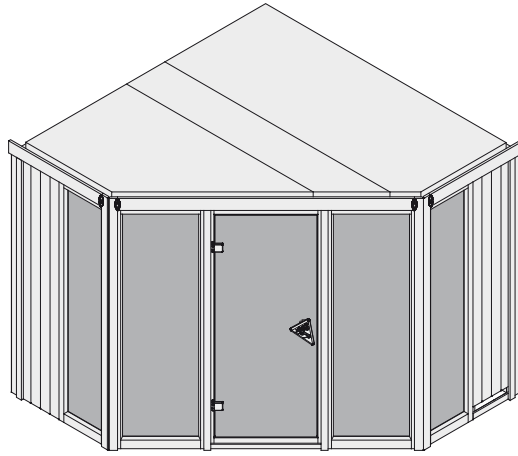

 **Aufbauanleitung**

 **Building Instructions**

 **notice de montage**

 **montagehandleiding**

 **Montagevejledning**

 **Instrucciones de construcción**

 **Istruzioni per il montaggio**

 **Montážní návod**





Bitte bewahren Sie die Anleitung und den Garantieschein zur Seriennummer auf.





Vernichten Sie diese erst nach Ablauf der Garantiezeit.





Eventuelle Beanstandungen können mithilfe der Stückliste einfacher zugeordnet werden.





Beigelegte Dokumente

- Informationsheft
- Garantieschein zur Seriennummer
- Typenschild inkl. Warnhinweise (Sauna)
- ggf. Zubehör-Anleitungen in externen Paketen





- *  Nicht im Lieferumfang enthalten
 Not included
 Non comprises dans la livraison
 Niet bijgeleverd

-  No forman parte del suministro
 Non incluso
 V ceně není zahrnuto
 Ikke inkluderet

- 1  Länge muss ermittelt und zugesägt werden
 Length must be determined and sawn
 La longueur doit être déterminée et sciée
 De lengte moet worden bepaald en worden gezaagd

-  La longitud debe ser determinada y aserrada
 La lunghezza deve essere determinata e segata
 Délka musí být určena a rozřezána
 Længden skal bestemmes og saves





- 2  Nicht gebraucht
 Not needed
 Pas nécessaire
 Niet nodig

-  No es necesario
 Non necessario
 Není nutná
 Ikke nødvendigt





- 3  Mit Zubehör
 With accessories
 Avec accessoires
 Met toebehoren

-  Con accesorios
 Con accessori
 S příslušenstvím
 Med tilbehør

- 4  Fixiert vorübergehend
 Fixed temporarily
 Temporairement fixe
 Tijdelijk vast

-  Temporalmente fijo
 Temporaneamente fisso
 Dočasně pevný
 Midlertidigt rettet

- 5  Bestand vom Haus
 Inventory of the house
 Inventaire de la maison
 Inventaris von het huis

-  Inventario de la casa
 Inventario della casa
 Inventář domu
 Inventar af huset

Werkzeuge / Tools*

X

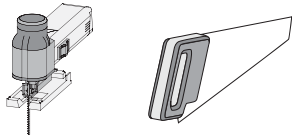

X

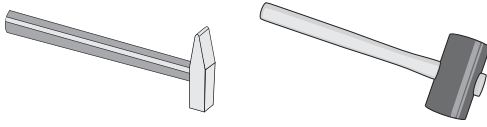

X

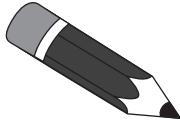

X

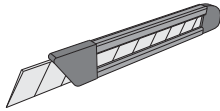
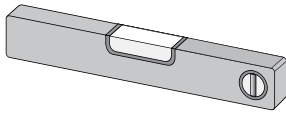

X

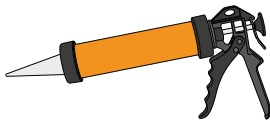
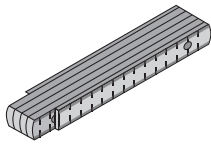

X

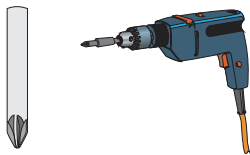

X

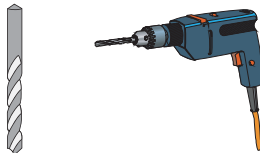

X

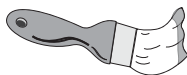

X



Technische Daten

In der Auftragsbestätigung bzw. Lieferschein ist der gekaufte Ofentyp bzw. das erworbene Steuergerät zu finden. Bitte entnehmen Sie die technischen Daten Ihrer Geräte der folgenden Auflistung

Gerät	Netzspannung	Wattage
Öfen		
9kW Ofen Bio	400V ~ 3N	9kW
9kW Ofen (Finnisch)	400V ~ 3N	9kW
9kW Ofen integr. Steuerung	400V ~ 3N	9kW
4,5kW Ofen Bio	400V ~ 3N	4,5kW
4,5kW Ofen (Finnisch)	400V ~ 3N	4,5kW
4,5kW Ofen integr. Steuerung	400V ~ 3N	4,5kW
3,6kW Ofen Bio	230V ~ 1N	3,6kW
3,6kW Ofen (Finnisch)	230V ~ 1N	3,6kW
3,6kW Ofen integr. Steuerung	230V ~ 1N	3,6kW
Steuergeräte		
externe Steuerung Easy Bio	400V ~ 3N	max. 10,8kW
externe Steuerung Plug&Play Bio	240V ~ 3N	max. 10,8kW
externe Steuerung (Finnisch)	400V ~ 3N	max. 10,8kW
externe Steuerung Plug&Play (Finnisch)	240V ~ 3N	max. 10,8kW
Multisteuergerät	400V ~ 3N	max. 10,5kW
externe Steuerung Classic Bio	400V ~ 3N	max. 9kW
externe Steuerung Classic (Finnisch)	400V ~ 3N	max. 9kW
externe Steuerung Premium Bio	400V ~ 3N	max. 12kW
externe Steuerung Premium (Finnisch)	400V ~ 3N	max. 9kW



Vergleichen Sie zuerst die Material-liste mit Ihrem Paketinhalt! Bitte haben Sie Verständnis, dass Beanstandungen nur im nicht aufgebauten Zustand bearbeitet werden können!



Vergelijk eerst de lijst van materialen met de inhoud van uw pakket! Reclamaties kunnen alleen in behandeling worden genomen zolang de onderdelen nog niet zijn gemonteerd!



Confrontate questa distinta materiali prima con il contenuto del pacchetto! Vi preghiamo di comprendere che eventuali reclami possono essere accolti solo prima del montaggio!



First compare the list of materials with your package contents! Please understand that complaints can be processed in the non-built status only!



Start med at kontrollere materialelisten med indholdet af den leverede pakke! Vi gør venligst opmærksom på at reklamationer kun kan behandles for materialer som ikke er blevet bearbejdet!



Nejprve přezkontrolujte obsah balení podle materiálového listu! Mějte pochopení pro to, že případnou reklamaci se můžeme zabývat pouze tehdy, když díly nebudou smontované! Za pomoci tohoto seznamu můžete jednotlivé díly přiřadit k montážnímu návodu.



Commencez par comparer la liste du matériel avec le contenu de votre paquet! Sachez que nous traitons uniquement les réclamations concernant le matériel à l'état non monté!



En primer lugar, compare la lista de material con el contenido del paquete. Rogamos entienda que las reclamaciones sólo pueden ser tramitadas antes de montar el objeto!

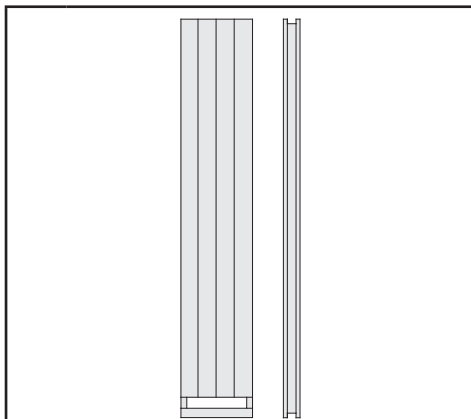
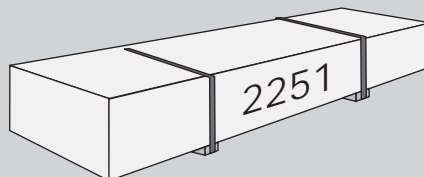

1 x W1 | 1920 x 344 x 68 mm | ID 2259

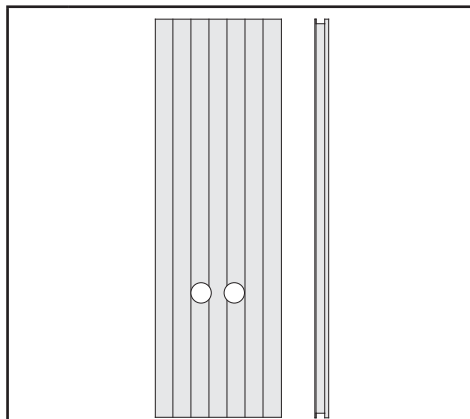

1 x W2 | 1920 x 606 x 57 mm | ID 23629

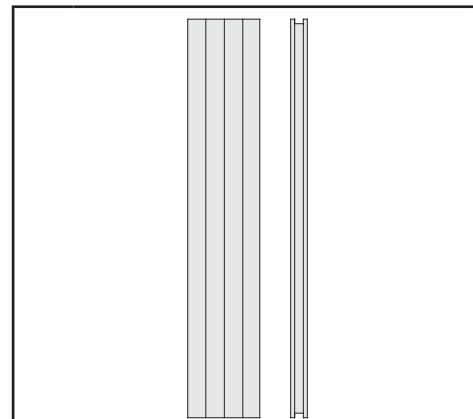

1 x W3 | 1920 x 344 x 68 mm | ID 52806

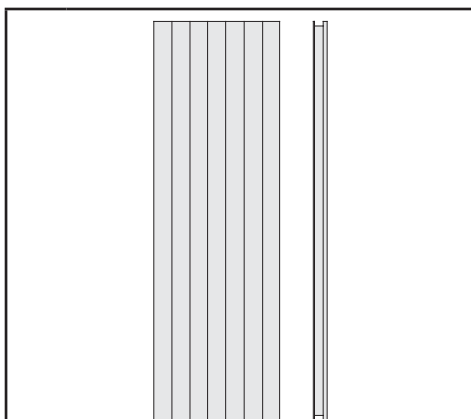

1 x W4 | 1920 x 606 x 57 mm | ID 23624

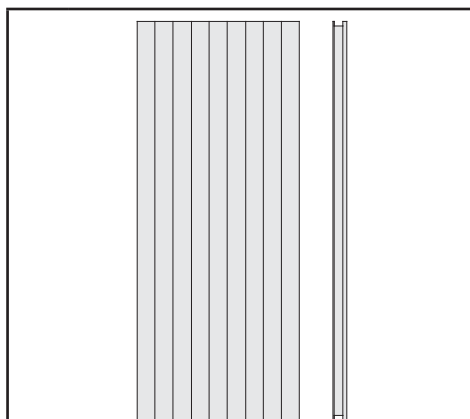

4 x W5 | 1920 x 780 x 57 mm | ID 23625

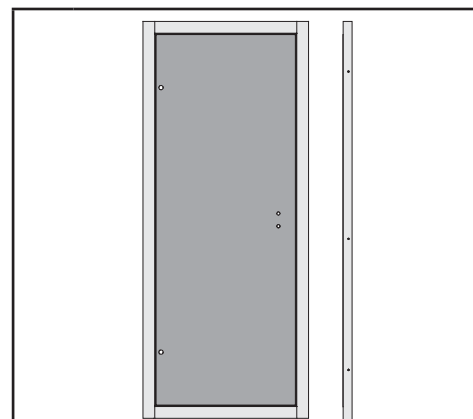

1 x W6 | 1872 x 750 x 68 mm | ID 43454

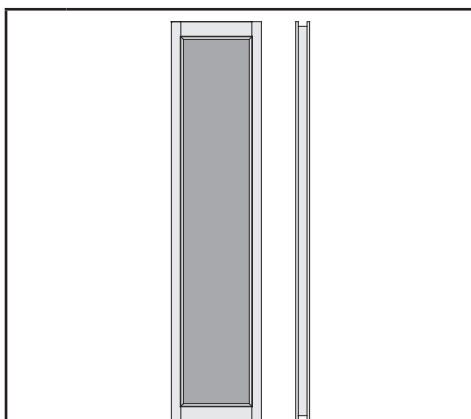

2 x W7 | 1920 x 433 x 68 mm | ID 56983

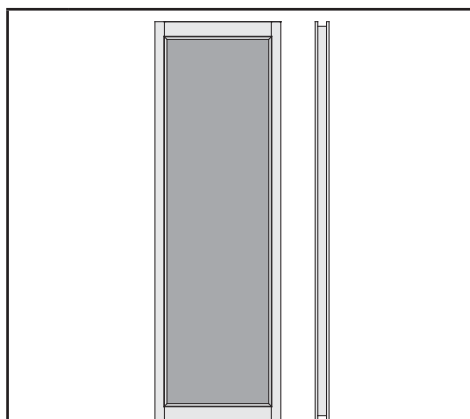

2 x W8 | 1920 x 606 x 68 mm | ID 47717

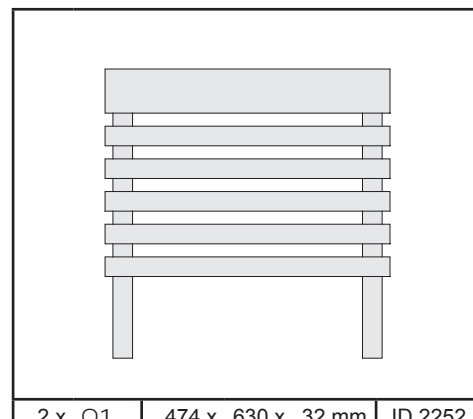

2 x Q1 | 474 x 630 x 32 mm | ID 2252
2 x Q2 | 580 x 630 x 32 mm | ID 2253

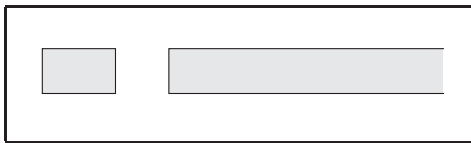

8 x B1	1920 x 19 x 3 mm	ID 20799
2 x B2	1920 x 20 x 12 mm	ID 52812
4 x B3	750 x 36 x 12 mm	ID 24239
1 x B4	964 x 90 x 16 mm	ID 2254
1 x B5	1255 x 90 x 16 mm	ID 2480
1 x B6	1606 x 90 x 16 mm	ID 2254
4 x B7	1884 x 45 x 18 mm	ID 48037
3 x B8	314 x 95 x 18 mm	ID 81102
2 x B9	845 x 95 x 18 mm	ID 52651
1 x B10	1912 x 95 x 18 mm	ID 52650
1 x B11	300 x 120 x 18 mm	ID 22467
1 x B12	1410 x 42 x 28 mm	ID 24101
1 x B13	2110 x 42 x 28 mm	ID 43453
1 x B14	2160 x 42 x 28 mm	ID 24529
2 x B15	2187 x 42 x 28 mm	ID 24534
2 x B16	2271 x 42 x 28 mm	ID 36179
3 x B17	1874 x 52 x 52 mm	ID 26165

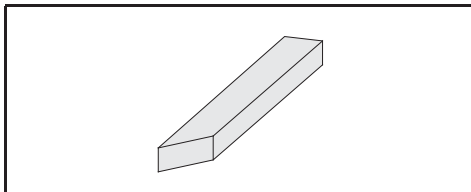

1 x C1	747 x 42 x 28 mm	ID 56491
1 x C2	774 x 42 x 28 mm	ID 56490
2 x C3	810 x 42 x 28 mm	ID 56632
2 x C4	852 x 42 x 28 mm	ID 56633

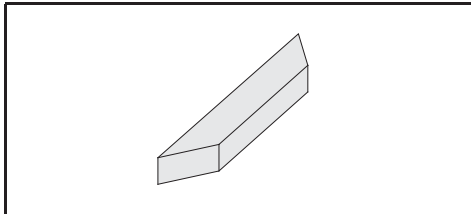

1 x C5	1960 x 42 x 28 mm	ID 56635
2 x C6	2007 x 42 x 28 mm	ID 56634

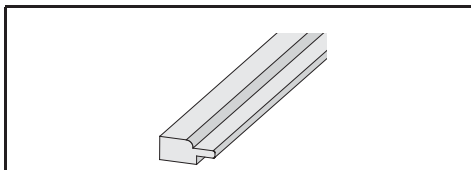

2 x E1	1920 x 30 x 12 mm	ID 24237
--------	-------------------	----------

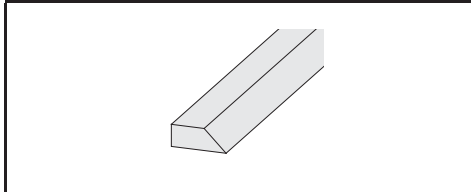

2 x E2	1884 x 45 x 17 mm	ID 48538
--------	-------------------	----------

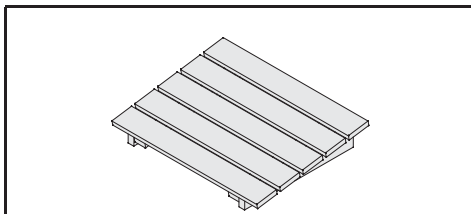

1 x	400 x 300 x 80 mm	ID 20708
-----	-------------------	----------

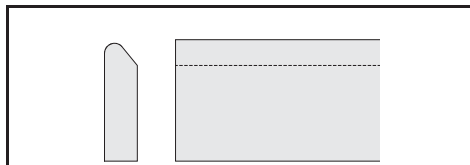

4 x G1	1980 x 58 x 17 mm	ID 52813
--------	-------------------	----------

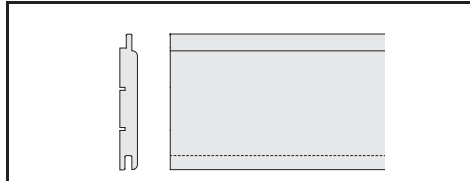

2 x R1	1920 x 97 x 12 mm	ID 22863
--------	-------------------	----------

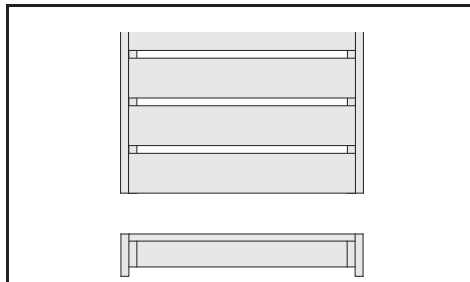

1 x L1	980 x 550 x 90 mm	ID 2478
1 x L2	1255 x 550 x 90 mm	ID 2477
1 x L3	2156 x 550 x 90 mm	ID 21768

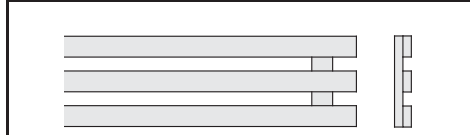

3 x L4	528 x 174 x 32 mm	ID 6917
1 x L5	947 x 174 x 32 mm	ID 2481
1 x L6	1236 x 174 x 32 mm	ID 2482
3 x L7	1606 x 174 x 32 mm	ID 2257

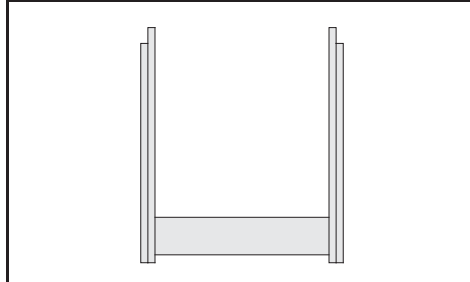

2 x L8	595 x 510 x 95 mm	ID 62992
2 x L9	895 x 512 x 95 mm	ID 16811



1 x		ID 26114
-----	--	----------

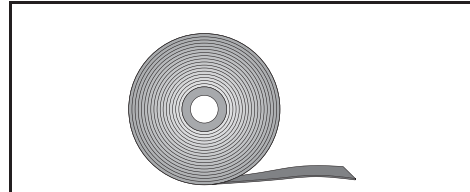

1 x	10 mm	ID 14025
-----	-------	----------

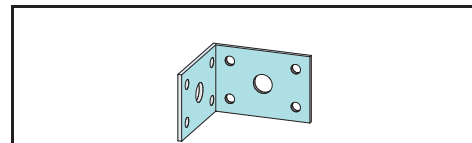

2 x	5 x 5 x 3,5 mm	ID 21292
-----	----------------	----------

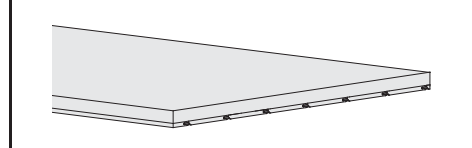

1 x M1	2049 x 349 x 57 mm	ID 25771
1 x M2	1699 x 918 x 57 mm	ID 25767

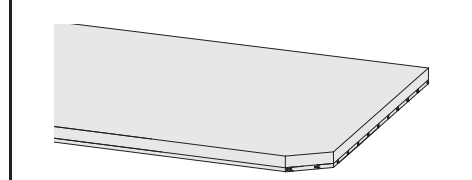

1 x M3	2187 x 918 x 57 mm	ID 24539
--------	--------------------	----------

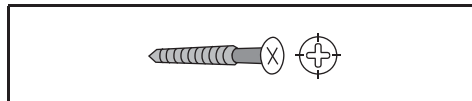

120 x	4 x 30 mm	ID 3686
60 x	4 x 50 mm	ID 3688
50 x	4 x 70 mm	ID 3689
40 x	4,5 x 80 mm	ID 9204
10 x	6 x 60 mm	ID 14014

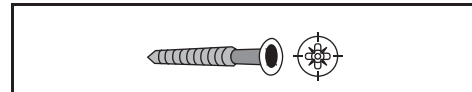

50 x	4,5 x 40 mm	ID 26285
------	-------------	----------

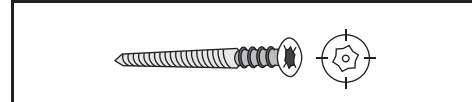

6 x	6 x 80 mm	ID 14266
-----	-----------	----------



50 x	4,5 x 30 mm	ID 26116
------	-------------	----------



3 x	8 x 70 mm	ID 42172
-----	-----------	----------

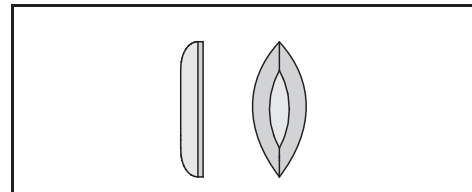

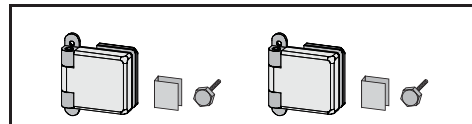

4 x		ID 26272
-----	--	----------



1 x		ID 26496
-----	--	----------

 Übersicht
 Overview
 enquête

 overzicht
 undersøgelse
 estudio

 sondaggio
 přehled

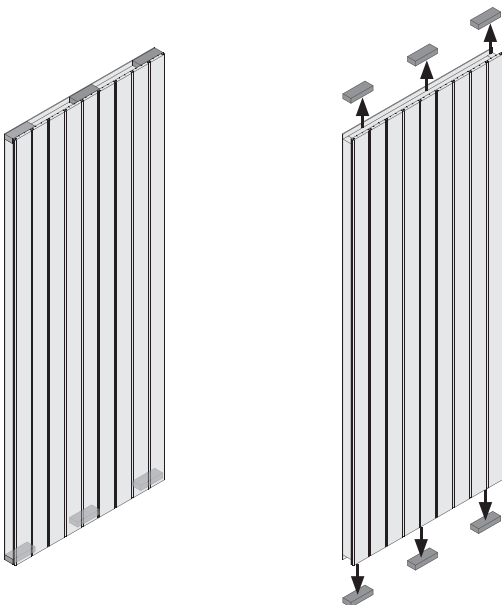
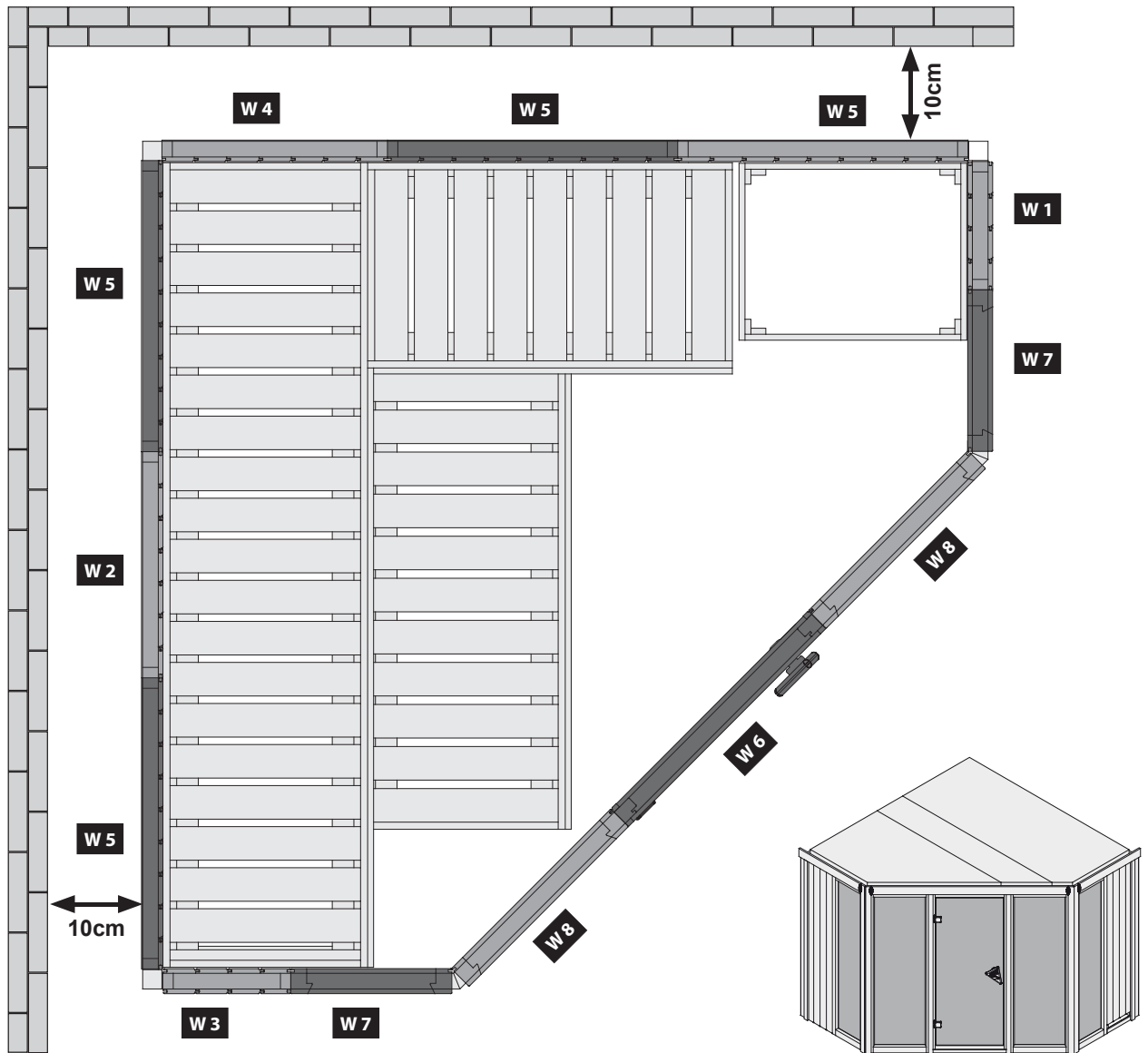



 Vorsicht!
 Attention!
 Attention!
 Voorzichtig!
 Forsigtig!
 Cuidado!
 Occhio!
 Pozor!

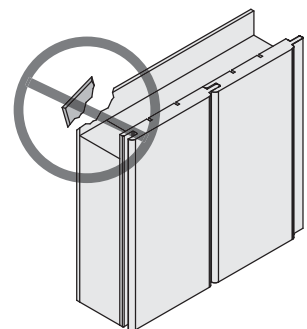

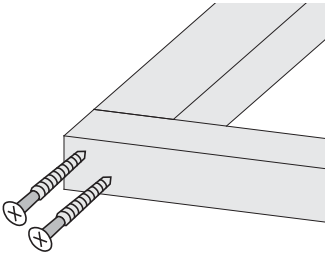

20x
Ø3 mm 4x70

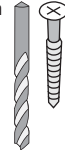
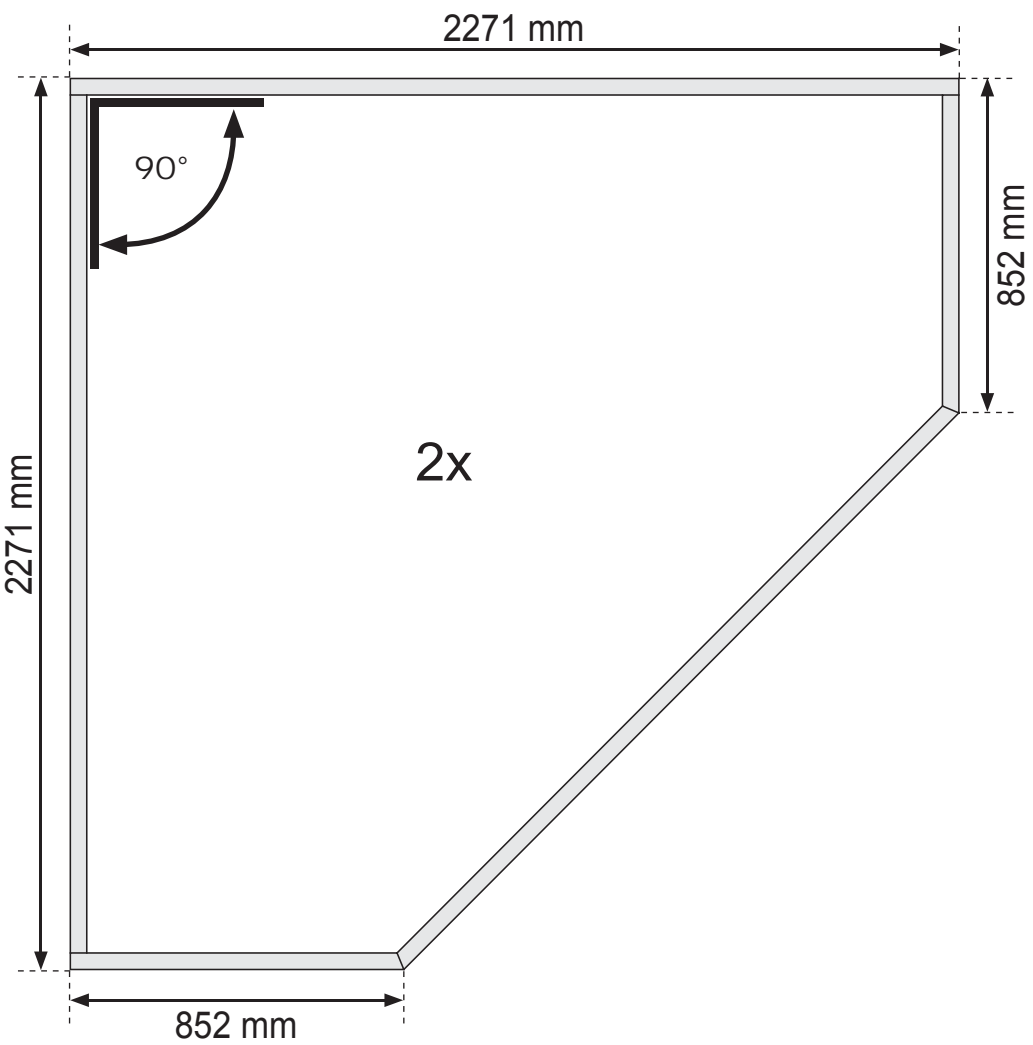
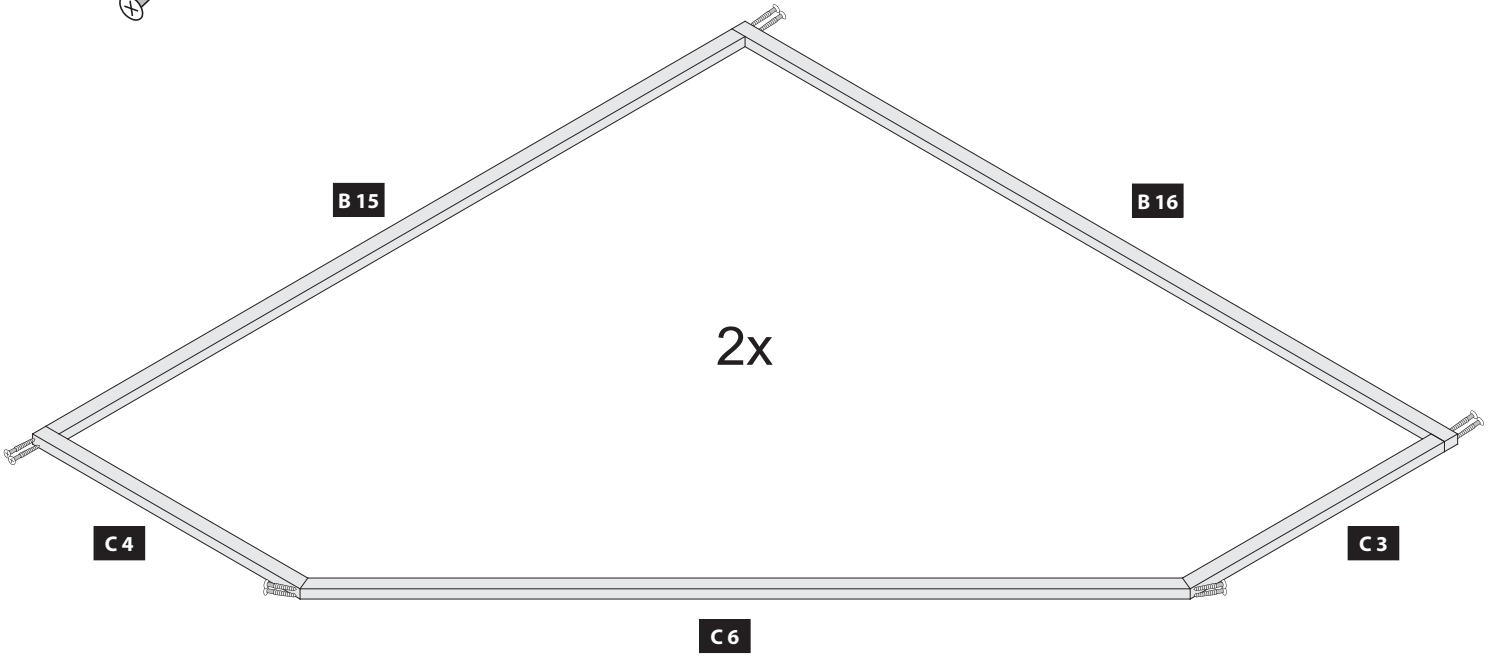
A diagram showing a 3 mm diameter drill bit and a 4x70 mm screw, which are the hardware used for assembly.

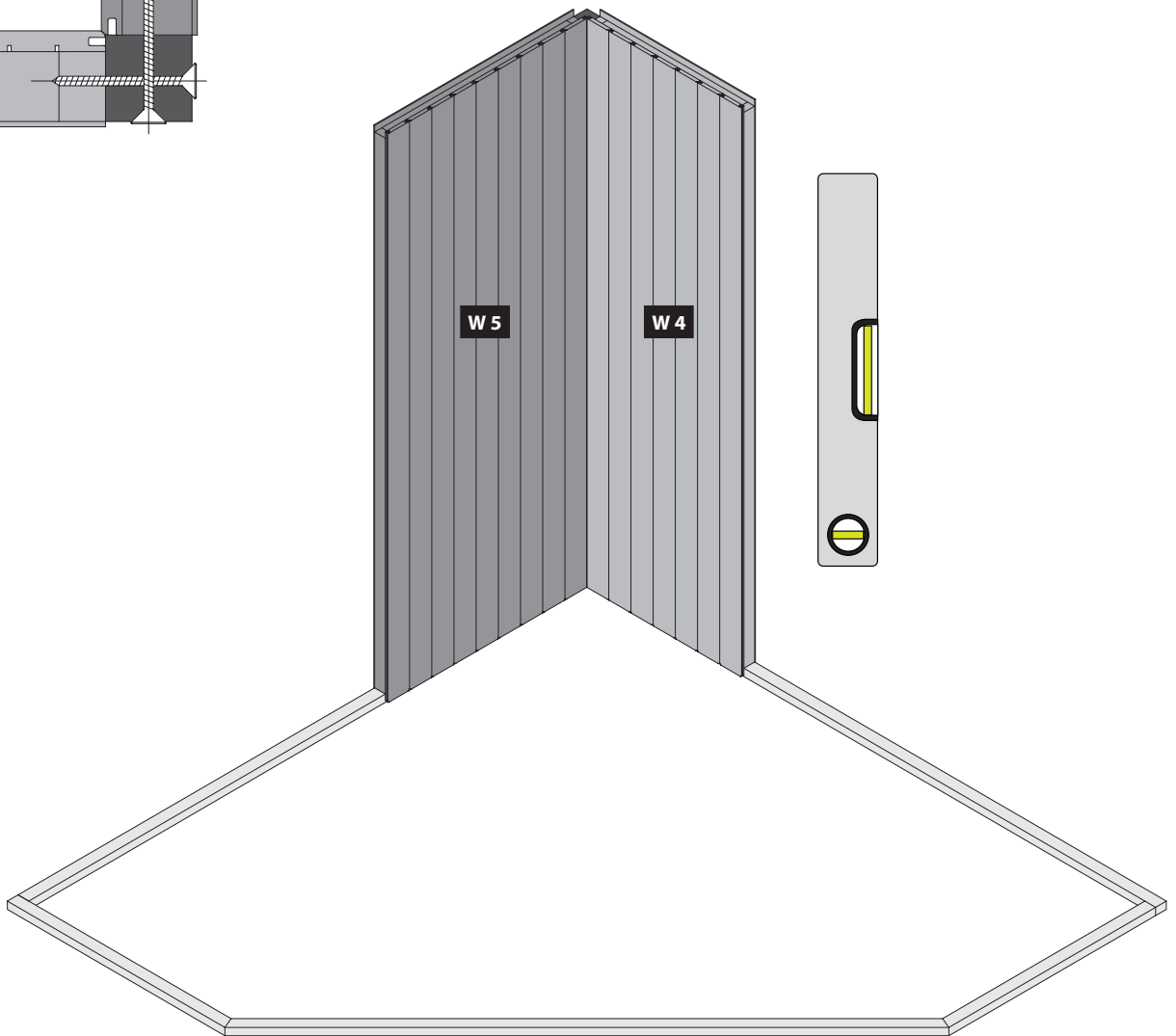
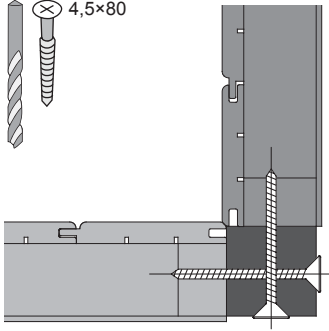
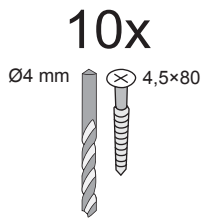
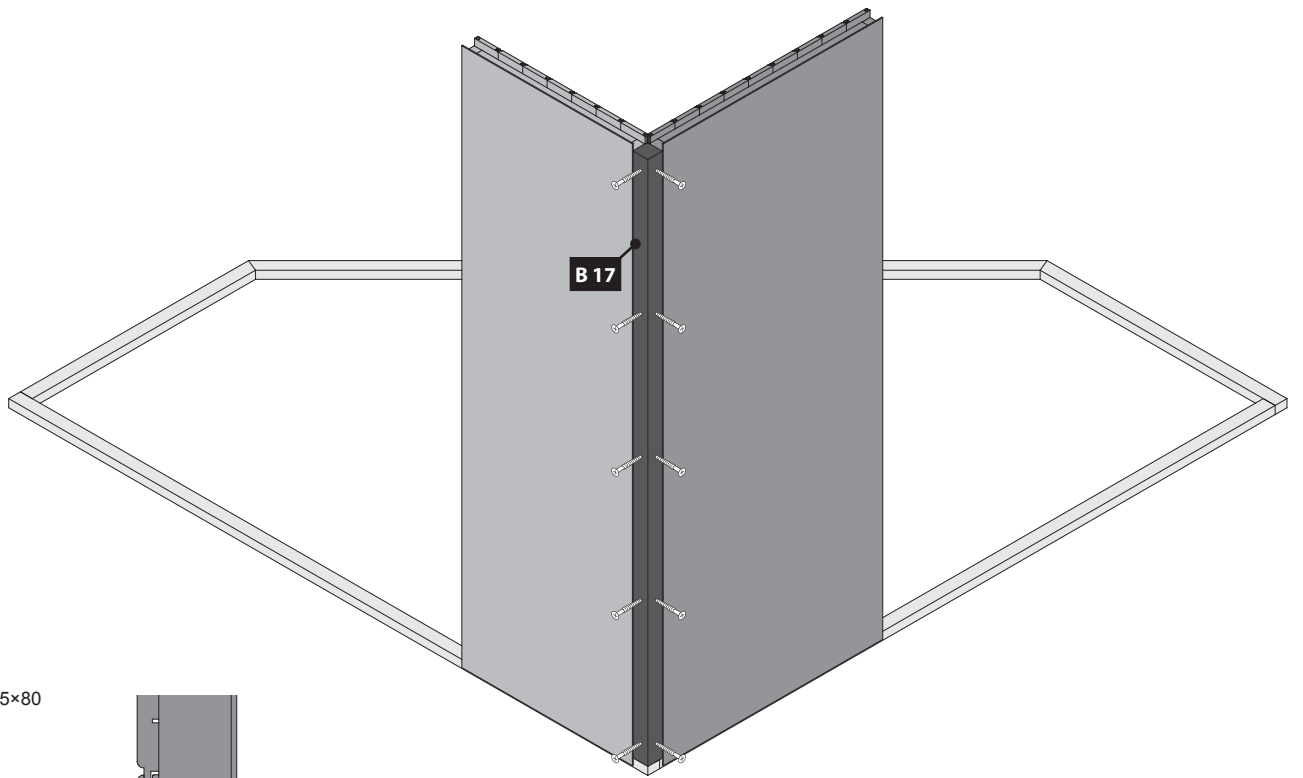

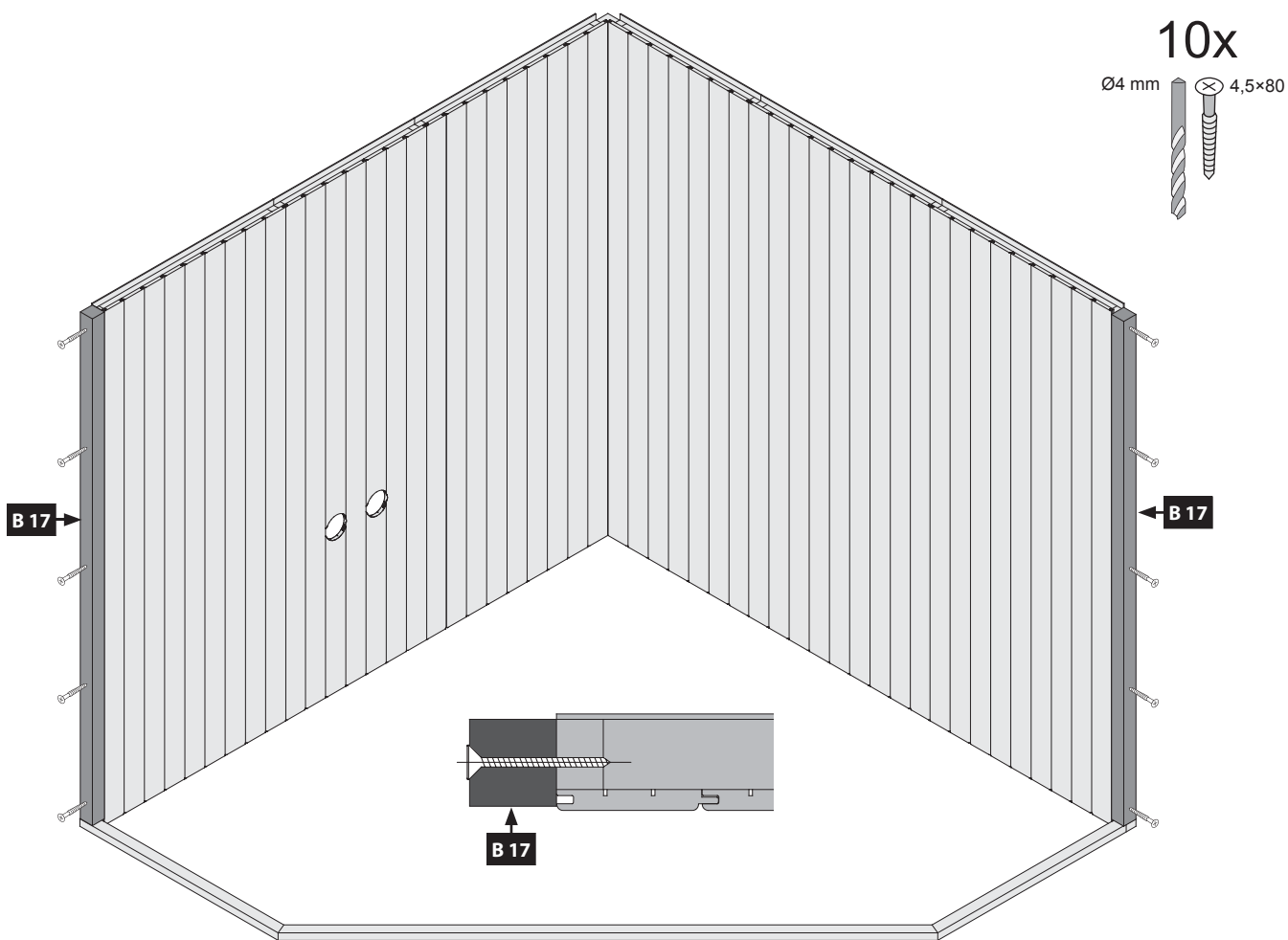
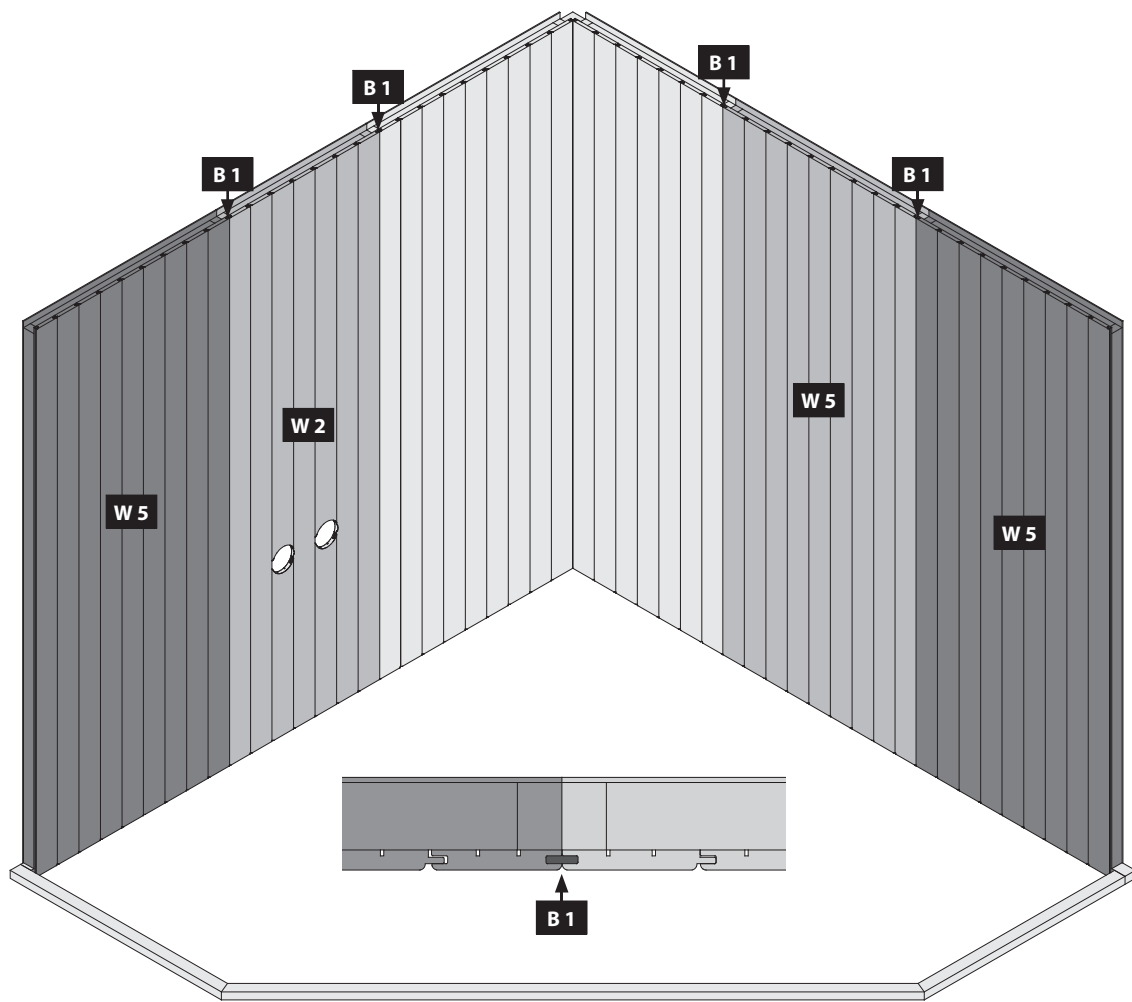

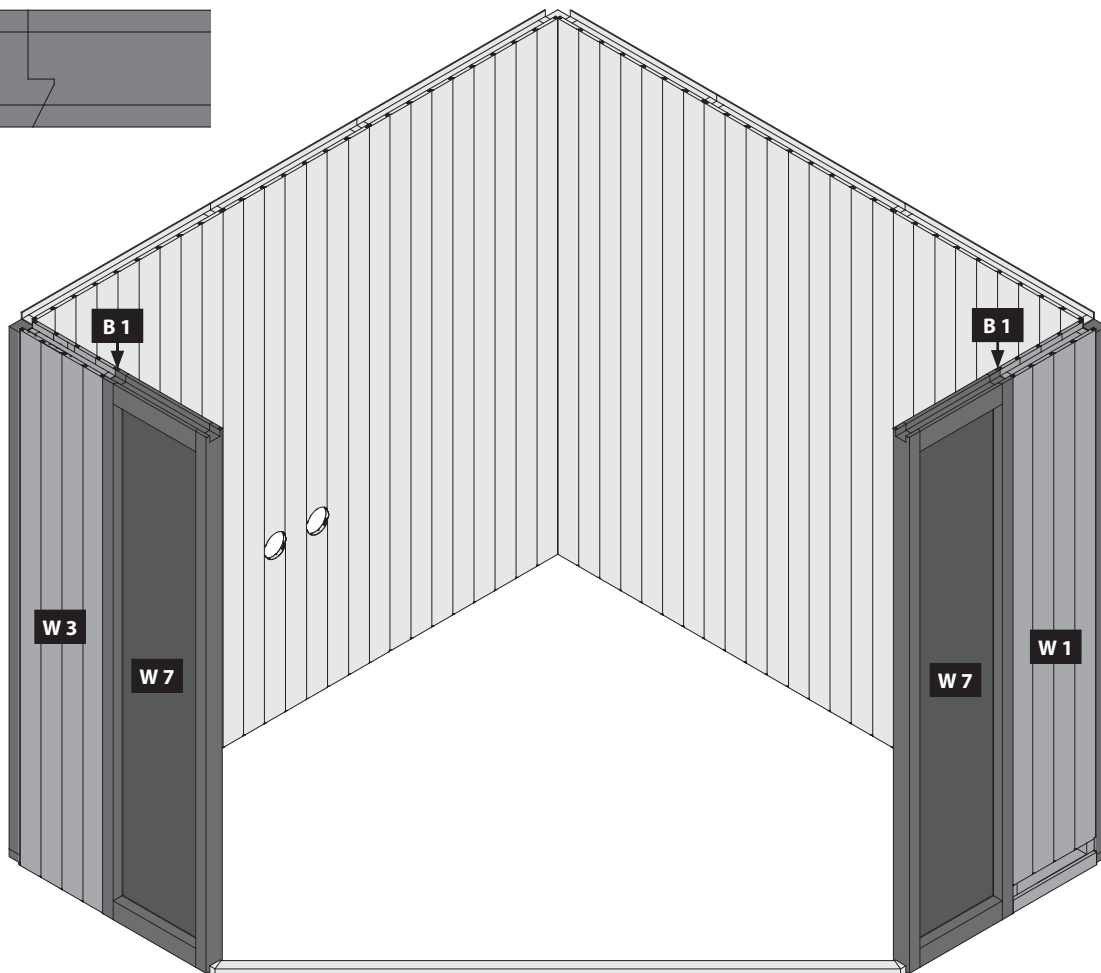
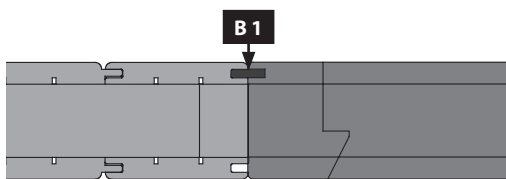
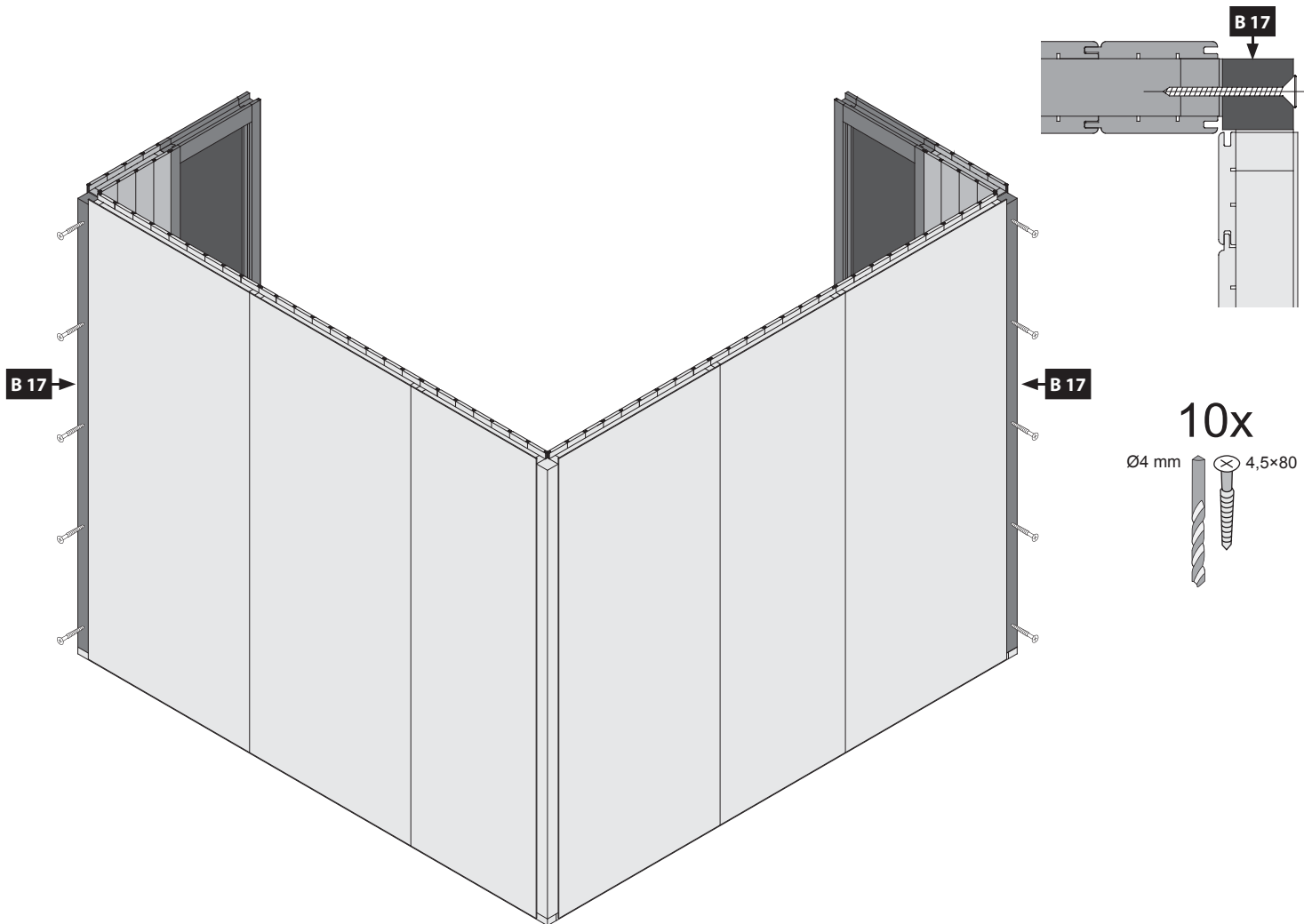

 Kabeldurchführung

 cable inlet

 entrée de câble

 kabel implementering





 kabelingang



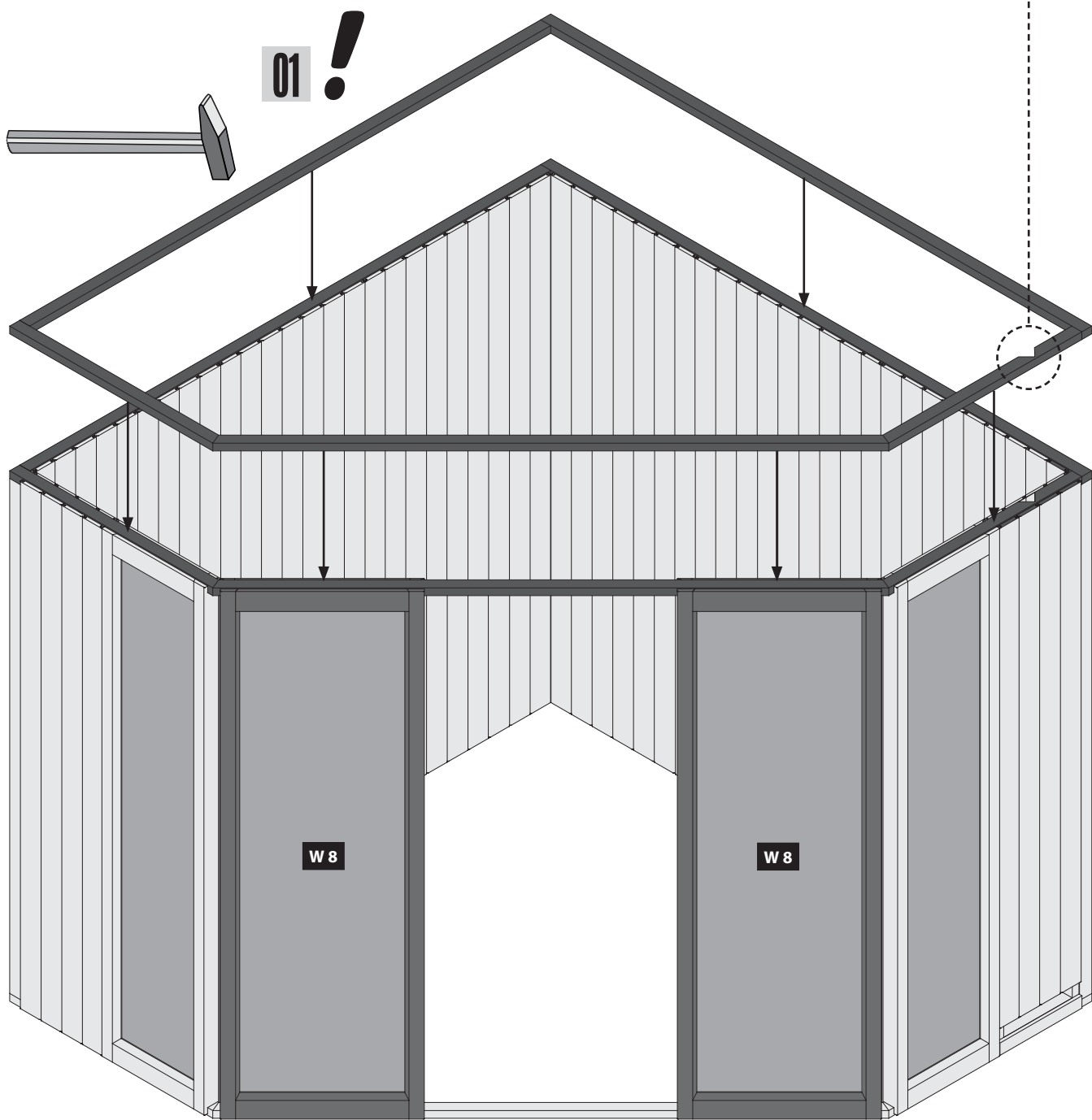
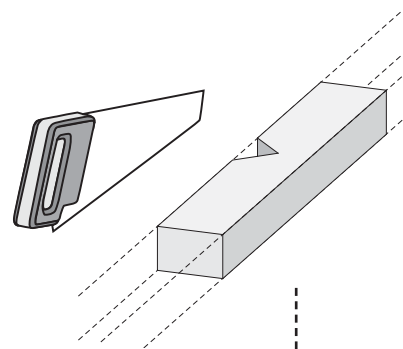

 entrada del cable

 ingresso cavi

 kabelová průchodka



-  Einbau Glastür
-  Installation of glass door
-  Montage porte en verre
-  Montage van de glazen deur

-  Installationsglasdør
-  Montaje de la puerta de cristal
-  Installazione portello di vetro
-  Sauna Instalace dveře

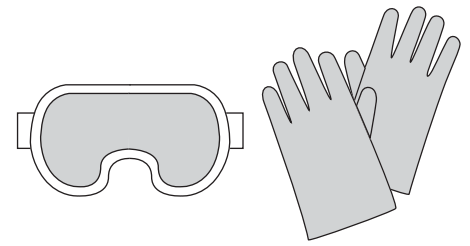

07

-  Saunatürglas in den Türrahmen legen
-  Put the door glass in the frame
-  Mettez le verre de la porte dans le cadre
-  Plaats het deurglas in het frame
-  Sæt dørglasset i rammen
-  Pon el vidrio de la puerta en el marco
-  Metti il vetro della porta nel telaio
-  Vložte sklo dveří do rámu

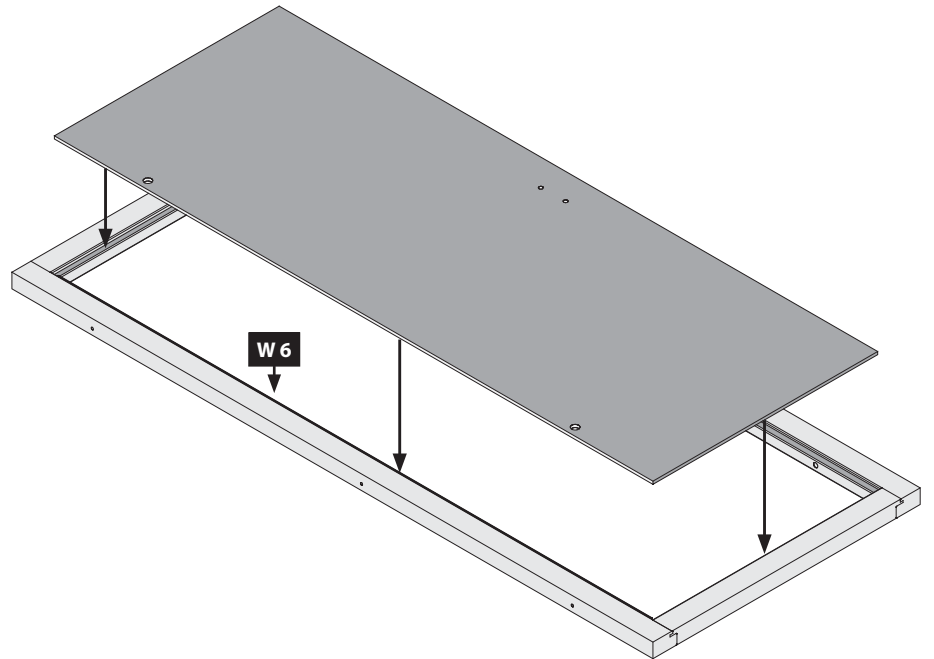

-  Saunatürglas in den Türrahmen ausrichten
-  Center the glass in the wooden frame
-  Bien aligner le verre à vitre
-  Lijn het glas uit in het deurframe
-  Juster saunaens dørglas i dørkarmen
-  Alinee el vidrio en el marco de la puerta
-  Allineare il vetro nel telaio della porta
-  Skleněná dvířka sauna v zárubně zarovnáni

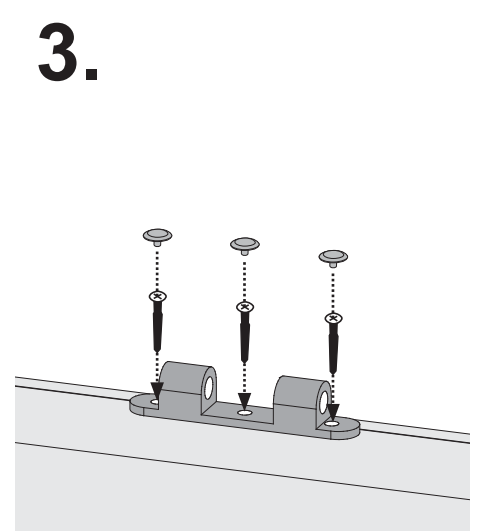
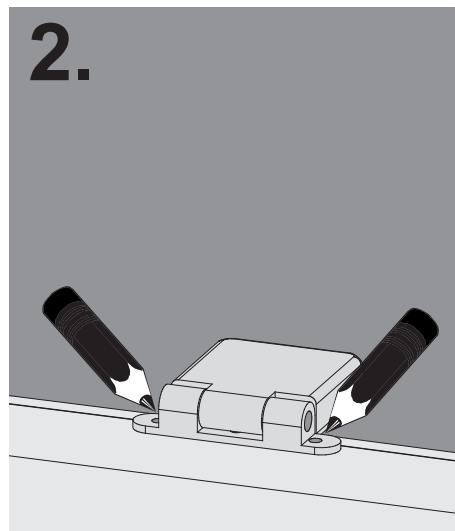
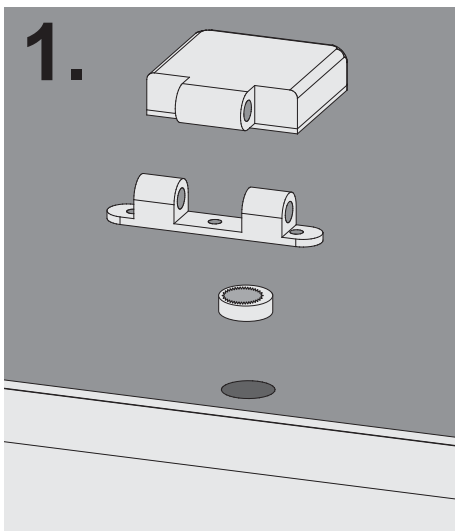
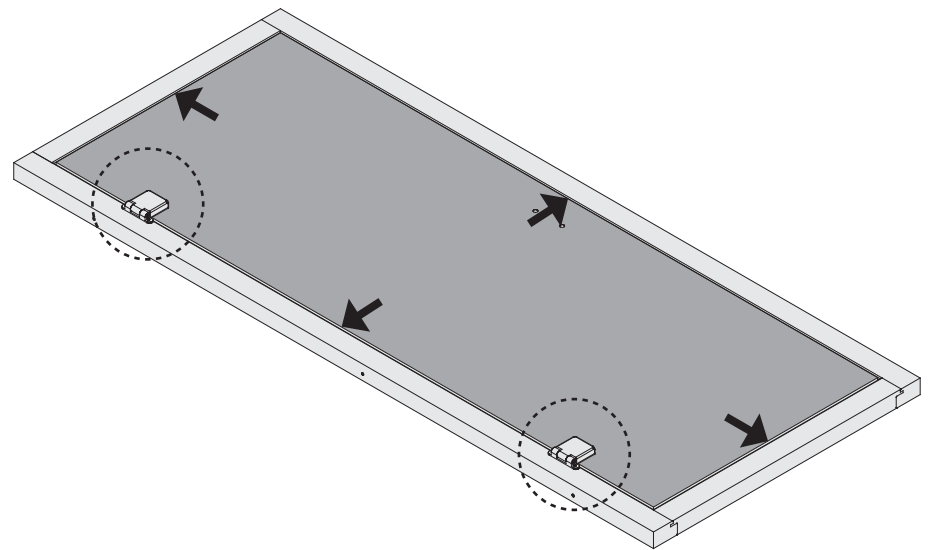

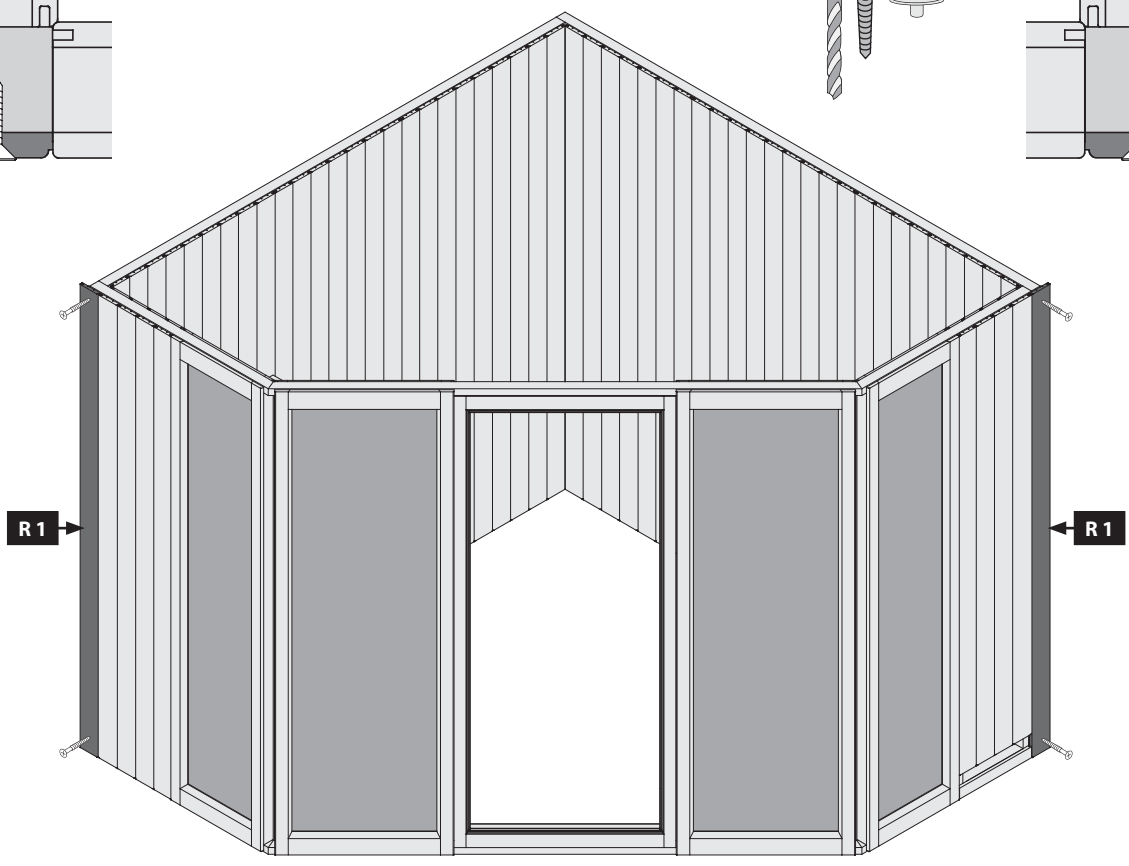
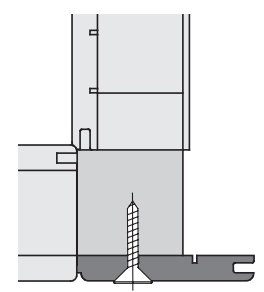
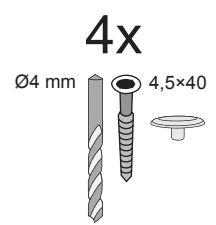
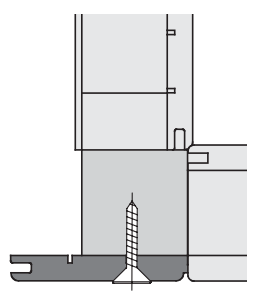
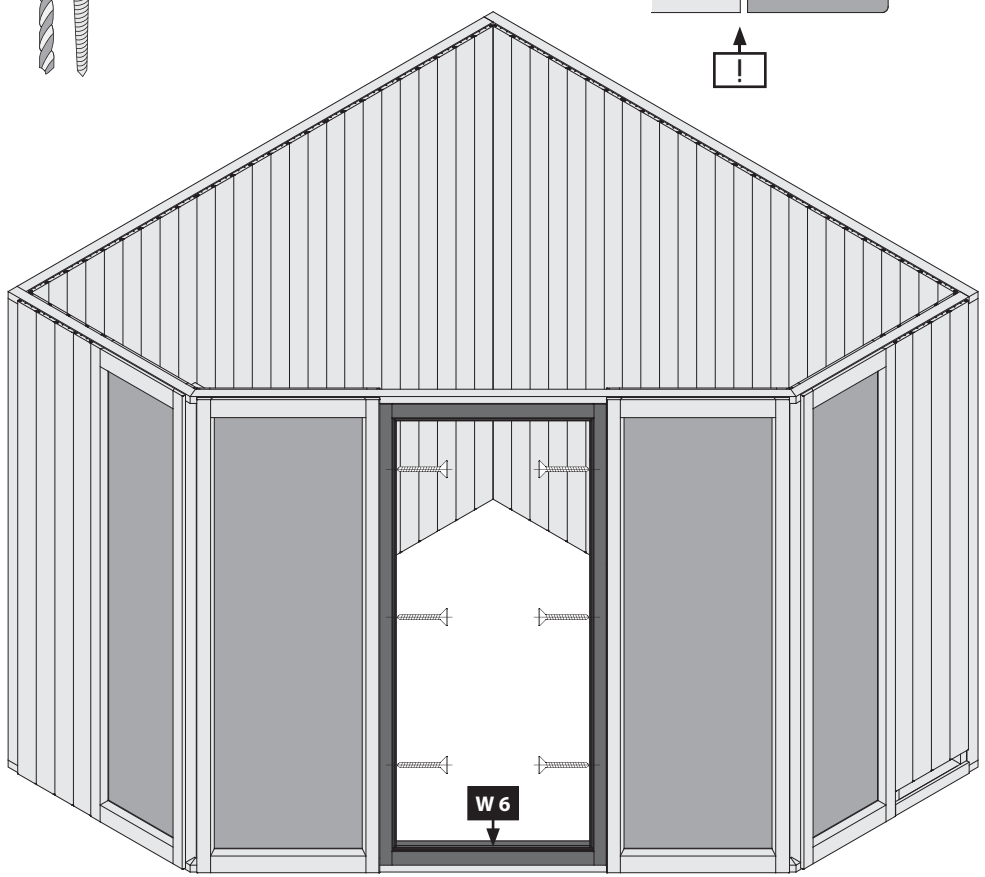
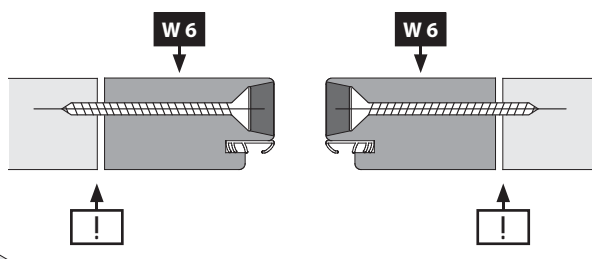
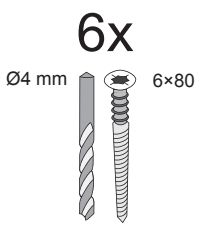

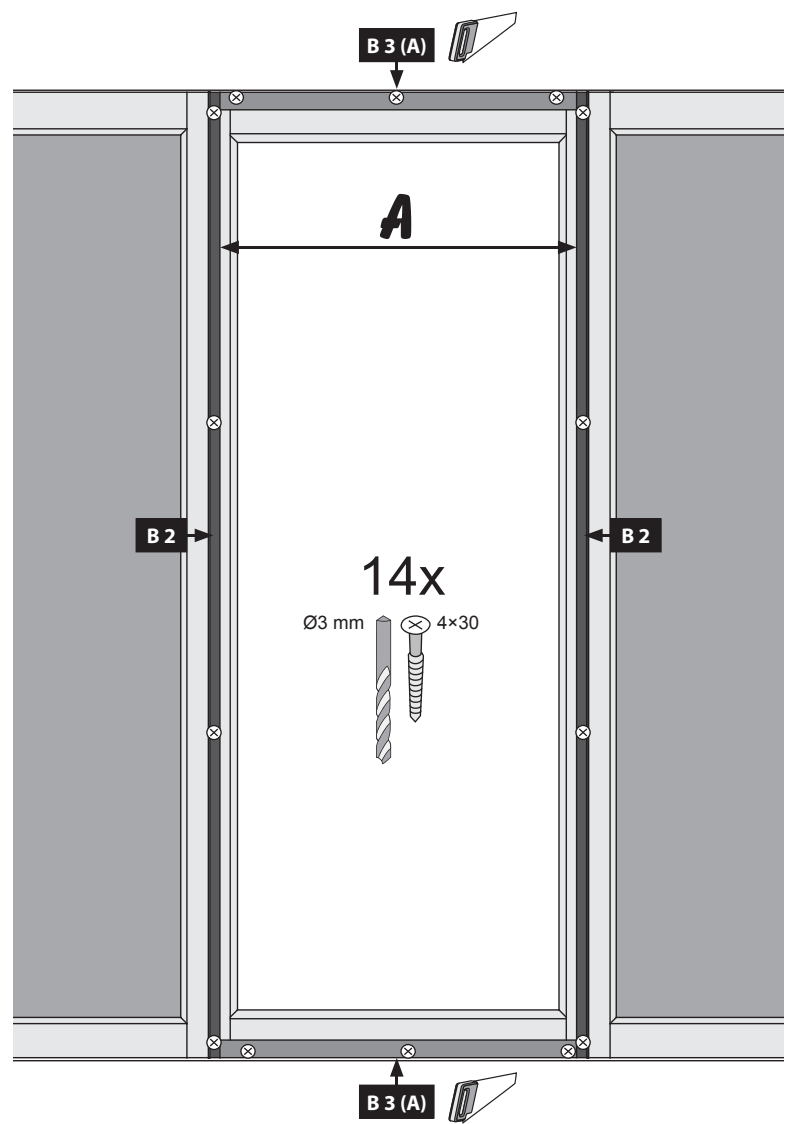
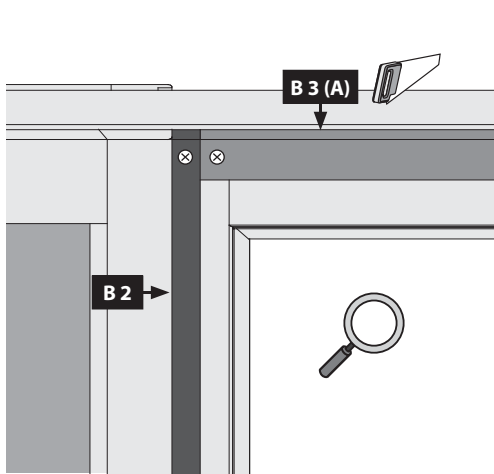
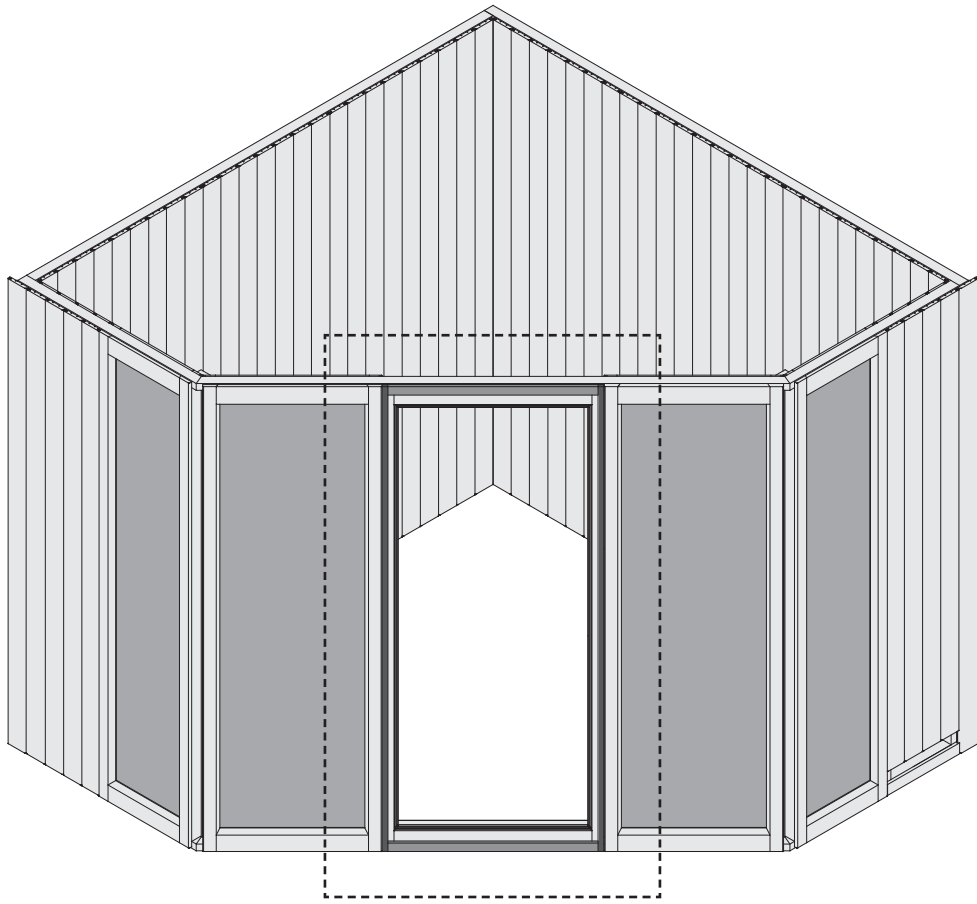

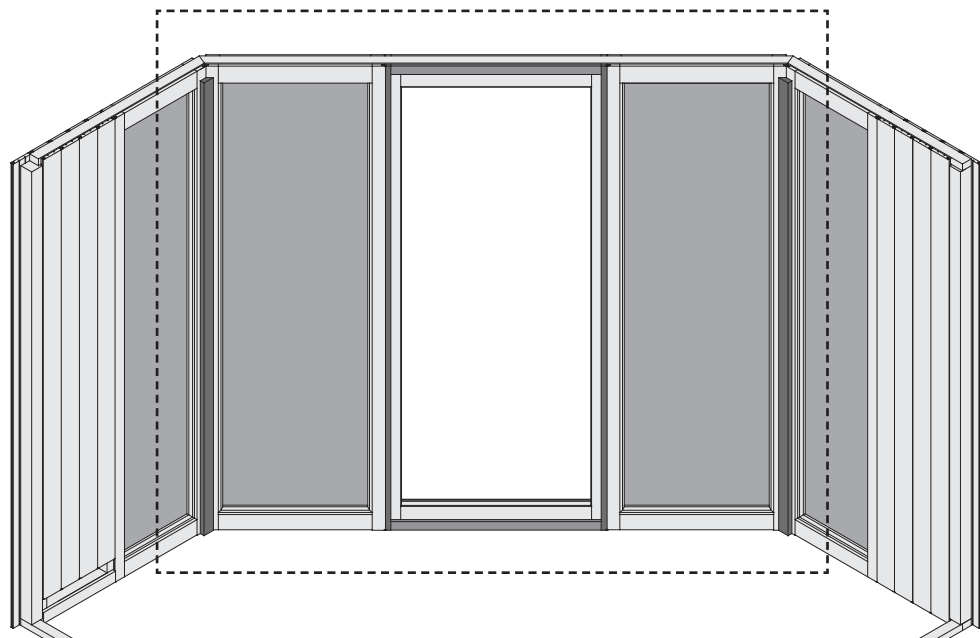

-  innen
-  Inside
-  à l'intérieur
-  binnen
-  dentro
-  dentro
-  uvnitř

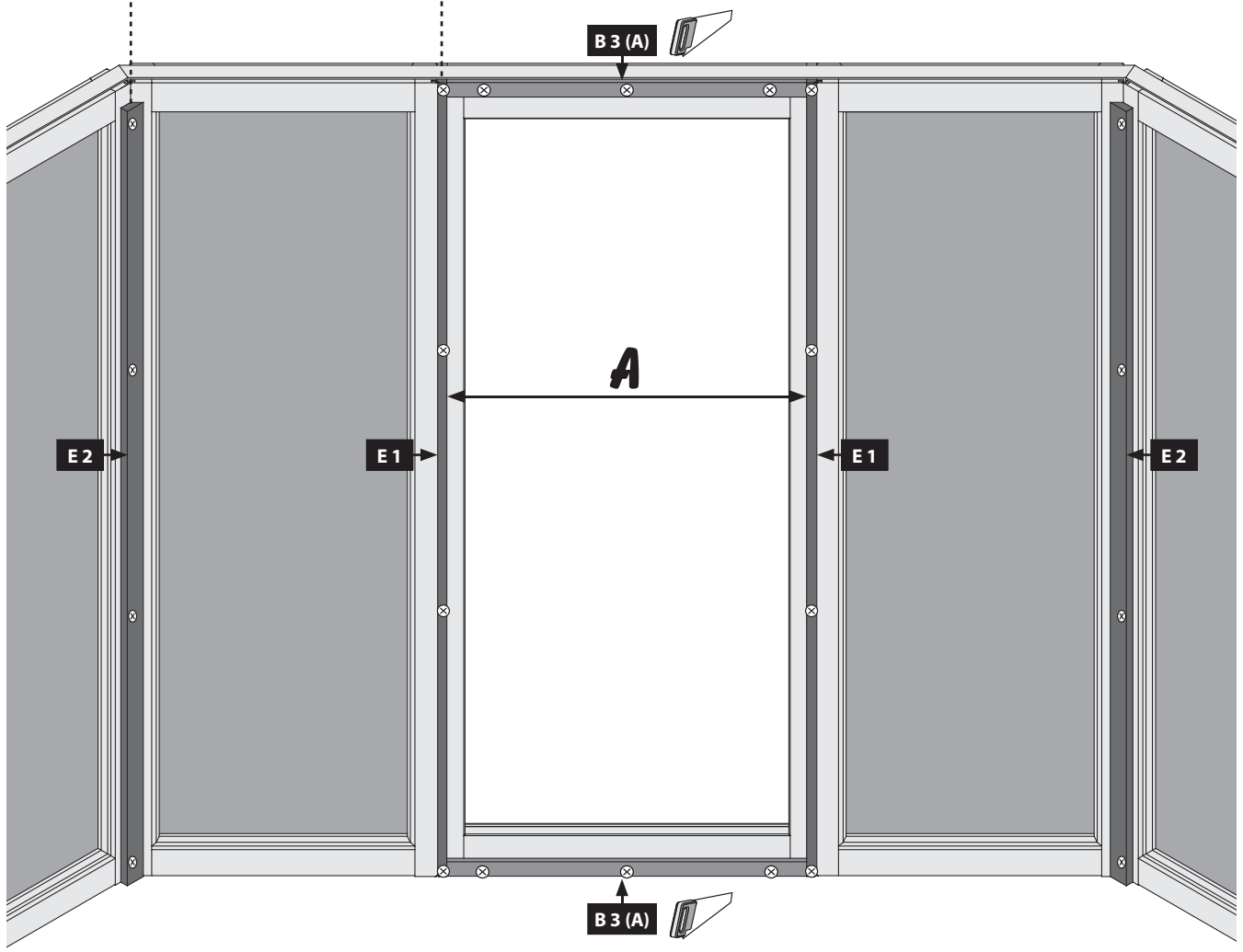
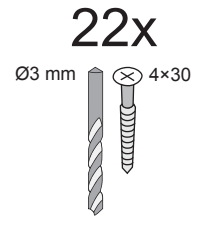
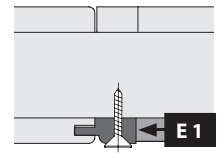
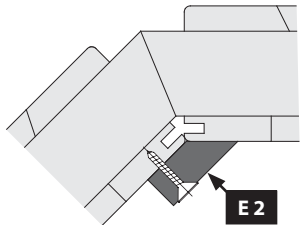

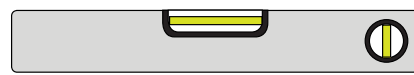

21x

Ø3 mm 4x50

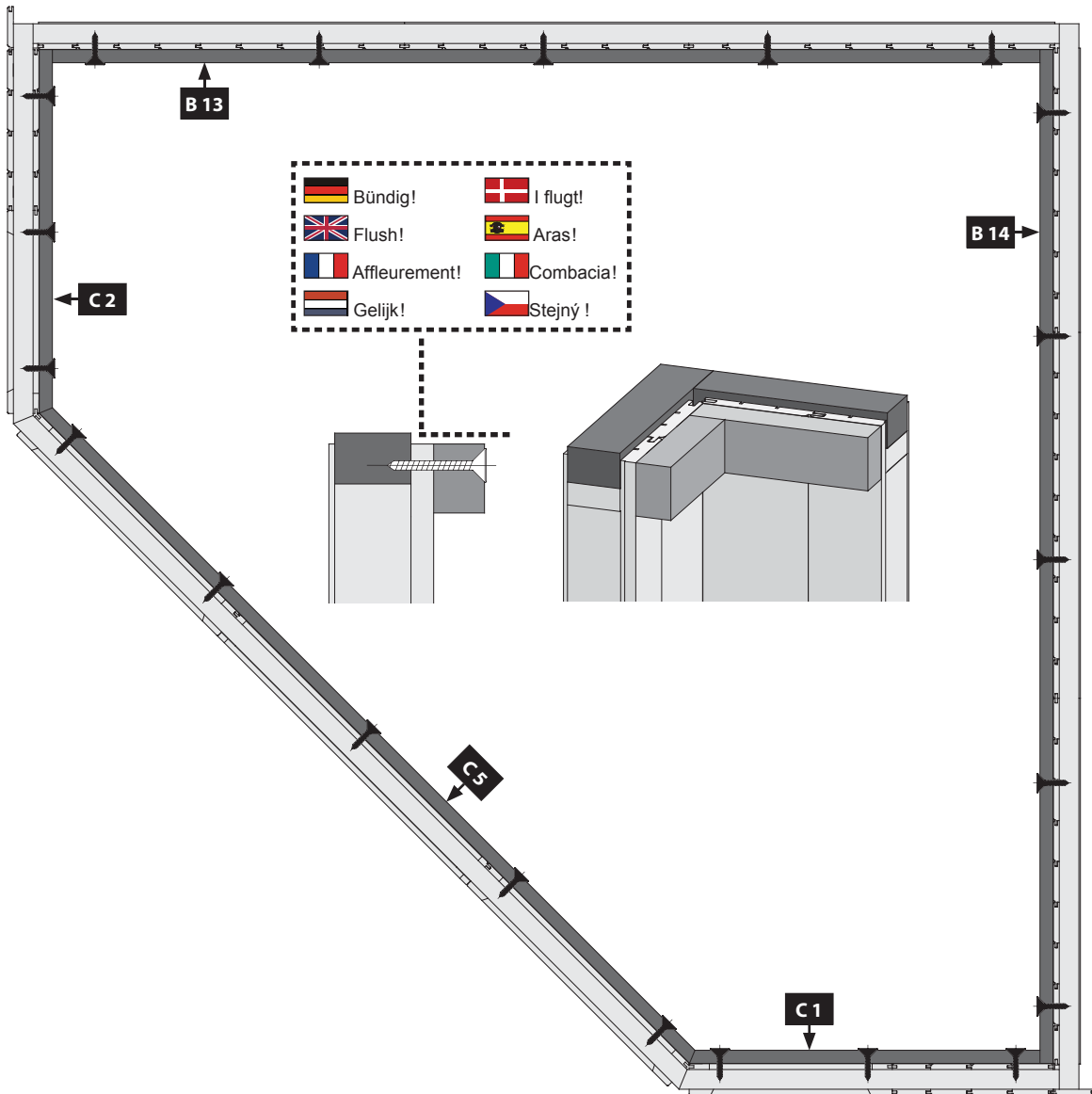
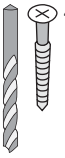

- | | | | |
|--|---------------|--|-----------|
| | Bündig! | | I flugt! |
| | Flush! | | Aras! |
| | Affleurement! | | Combacia! |
| | Gelijk! | | Stejný! |

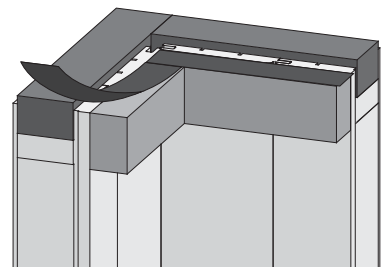
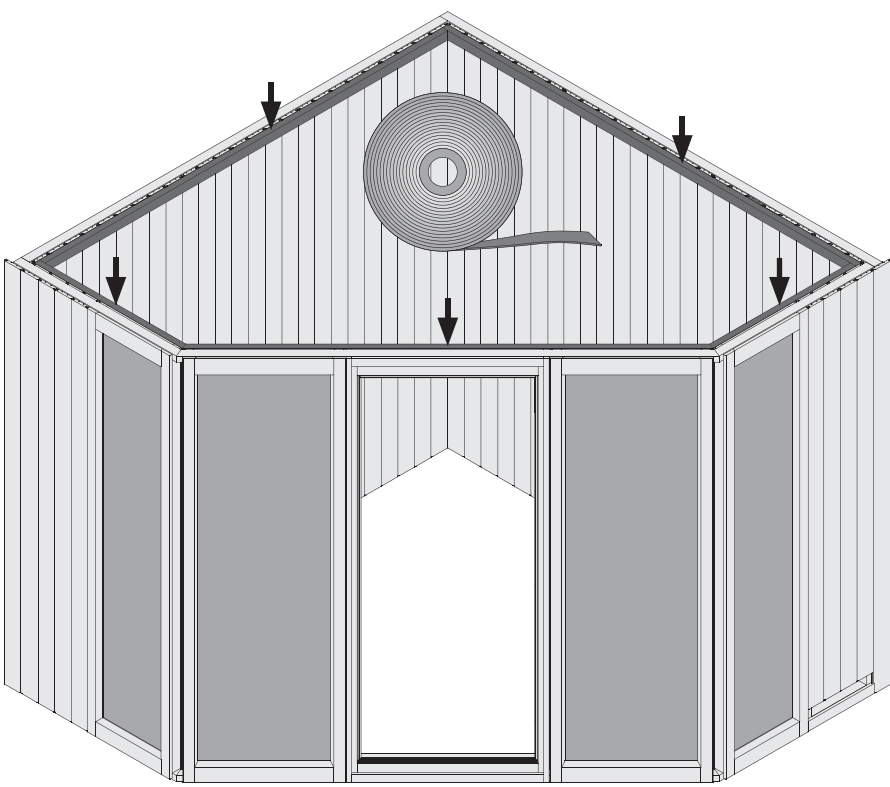
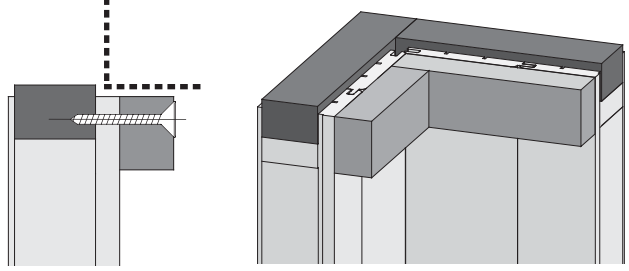

- Sauna Dichtband
- Sauna sealing tape
- Ruban d'étanchéité pour sauna
- Sauna tætningsbånd
- Sauna afdichtingstape
- Cinta de sellado de sauna
- Nastro sigillante per sauna
- Sauna těsnící páska

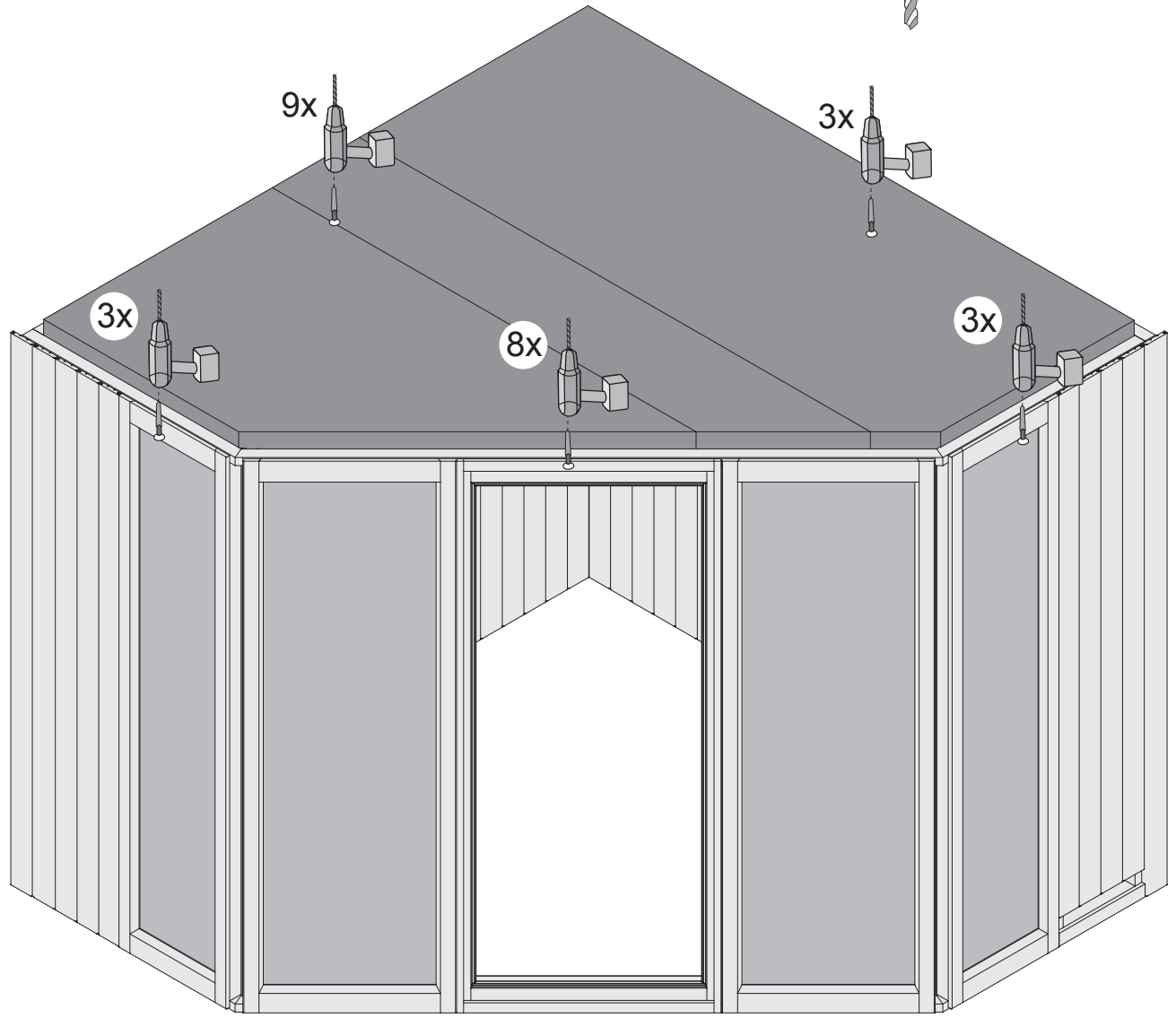
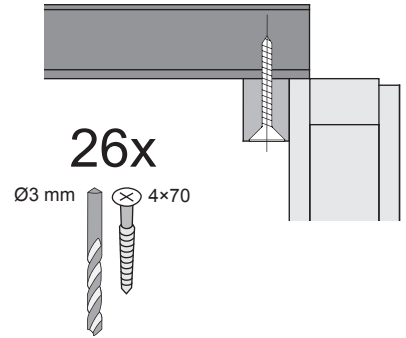
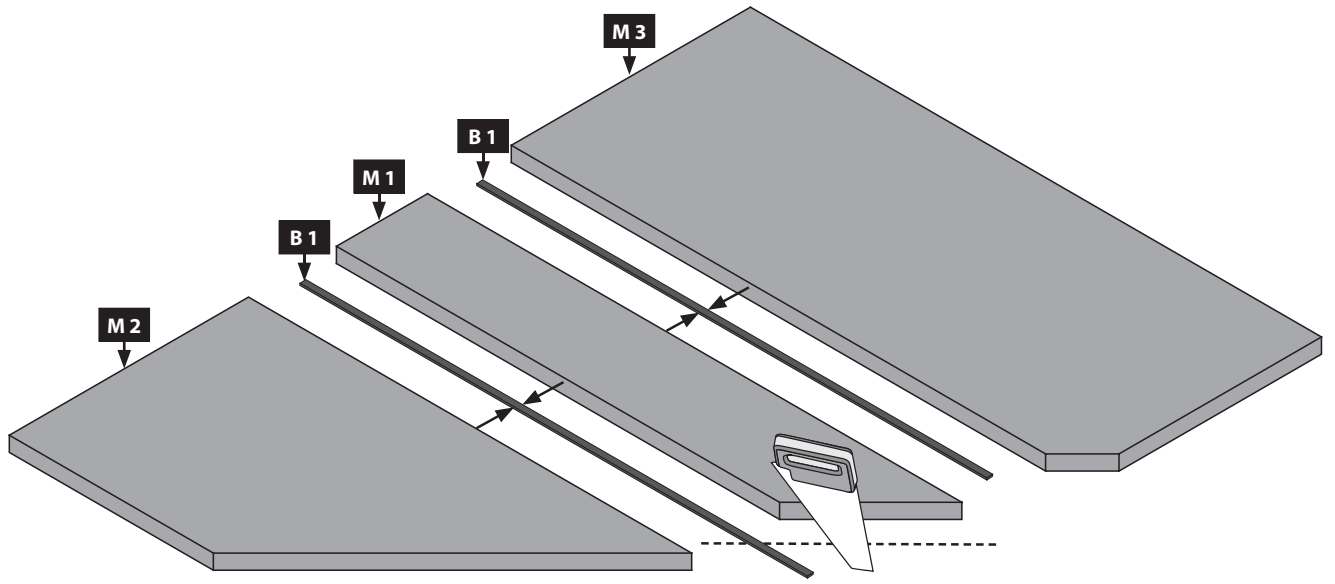





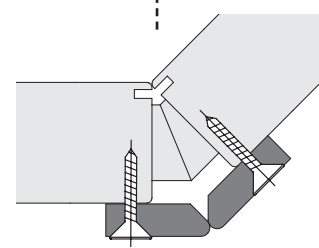
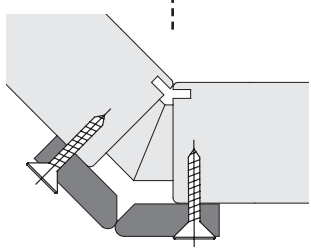
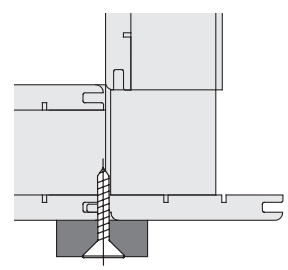
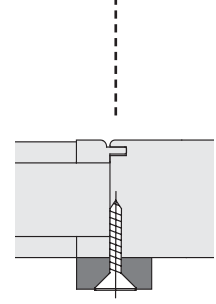
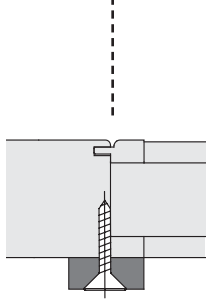
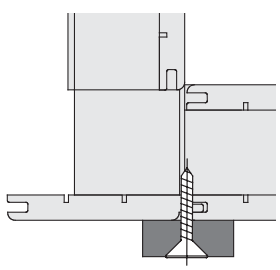
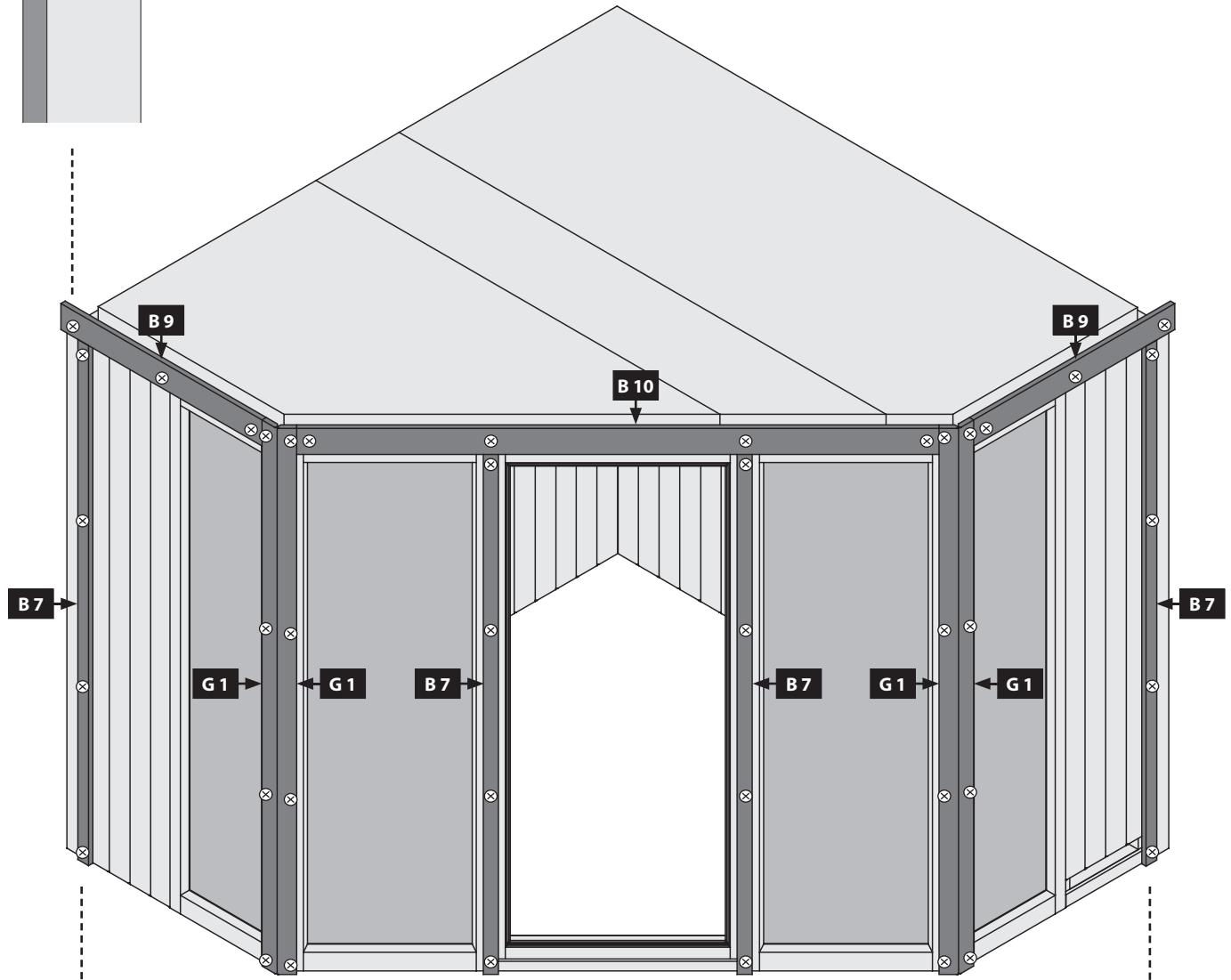
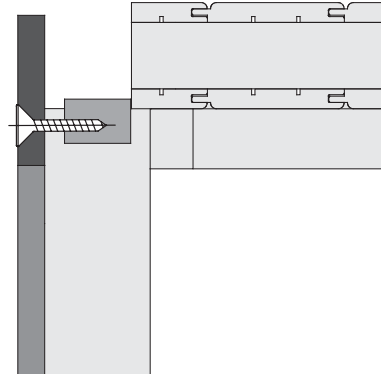

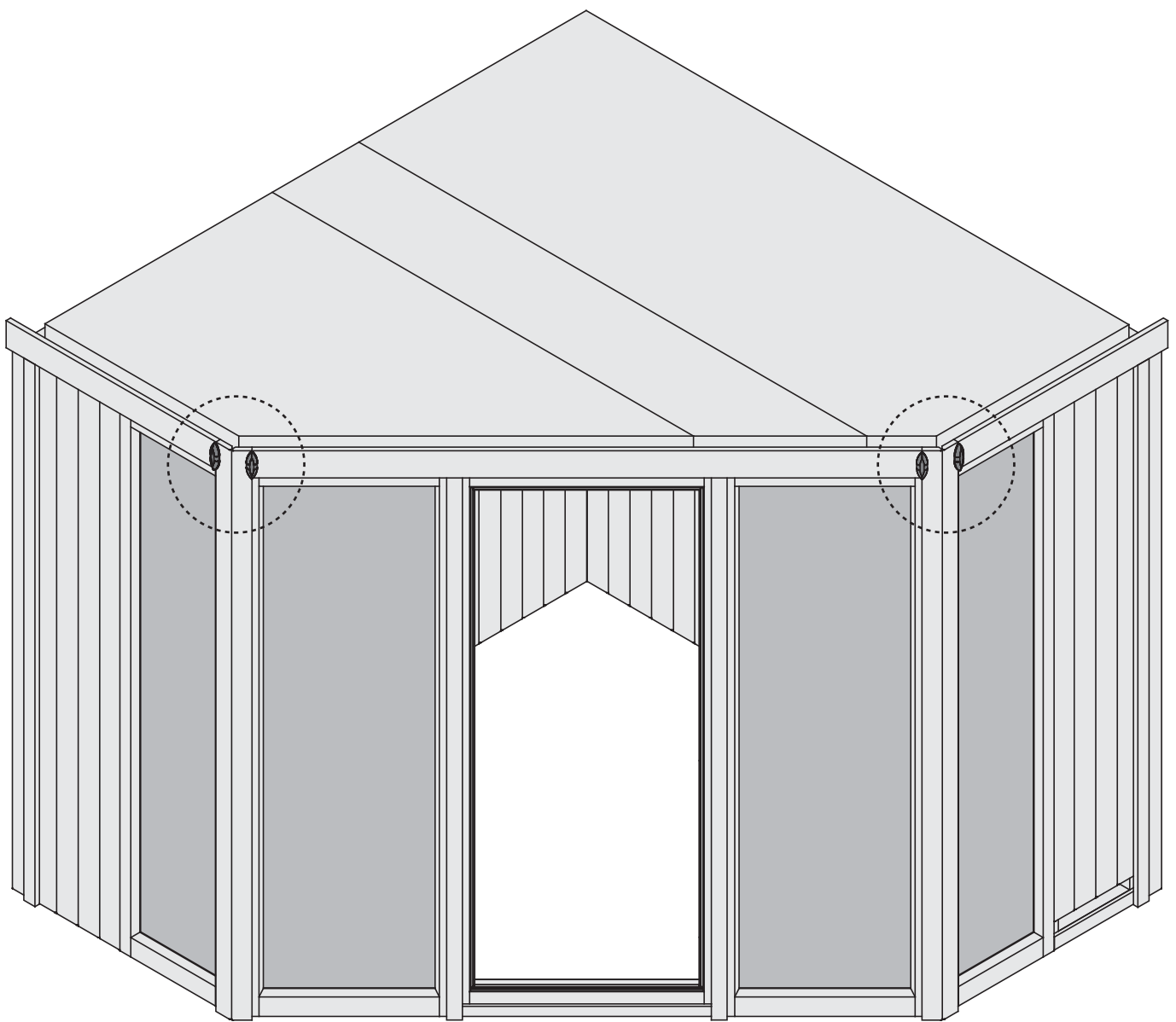
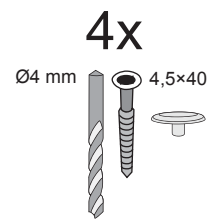
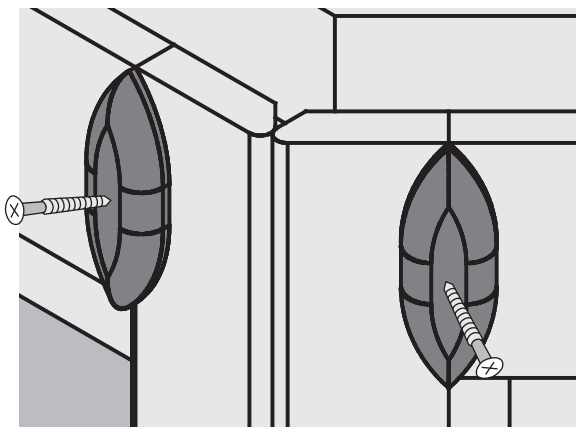

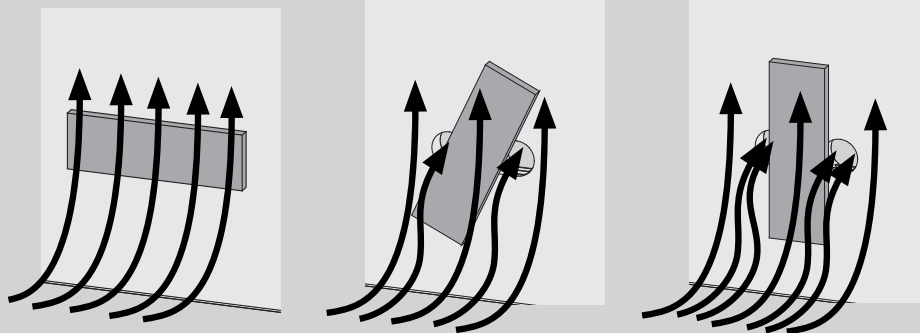
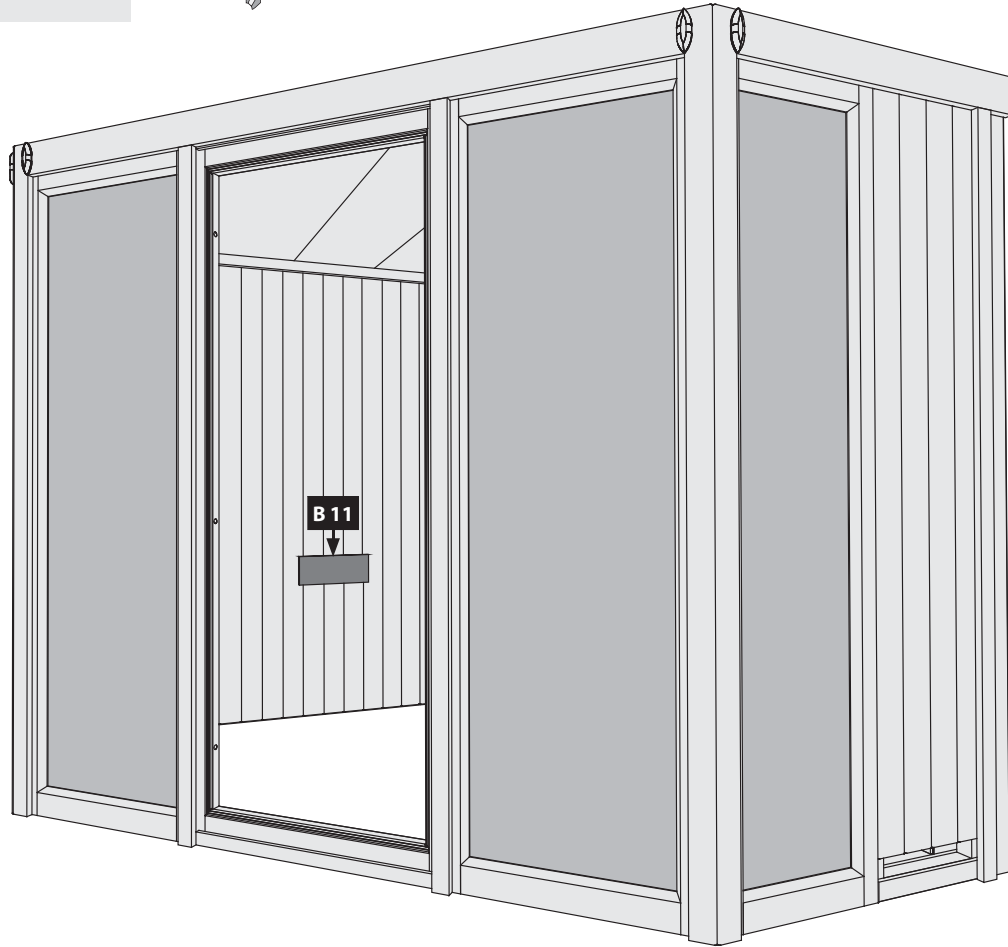
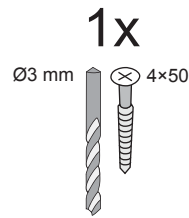
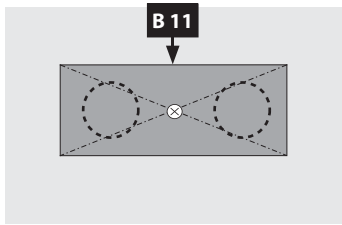

42x
Ø4 mm 4,5x40







-  Hier ist die Funktionsweise des Brettes abgebildet. Regeln Sie damit die Abluft nach Ihren eigenen Wünschen
-  This figure shows the functional principle of the board. Regulate the exhaust air according to your own wishes
-  Ceci représente le mode de fonctionnement de la planche. Avec elle, réglez l'écoulement de l'air selon vos désirs
-  Hier is de werking van het plankje afgebeeld. Regel daarmee de luchtafvoer naar eigen wens
-  Sådan fungerer styret. Brug den til at regulere udstødningsluften efter dine egne ønsker
-  Aquí está representada la forma de funcionamiento de la tabla. Regule con ello el aire de salida según sus propios deseos
-  Viene illustrato il principio di funzionamento della tavoletta di regolazione della ventilazione. Con essa si può regolare a piacere la ventilazione
-  Zde je zobrazená funkce desky. Regulujte s ní odsávací vzduch dle Vašeho přání

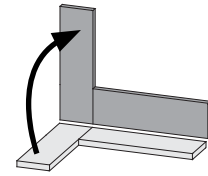
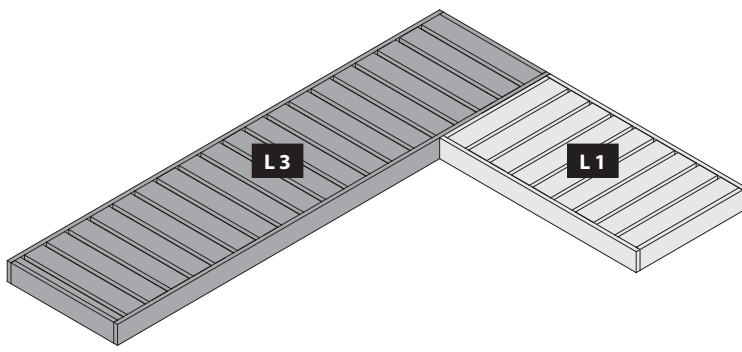

17

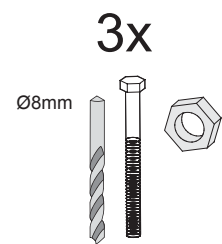
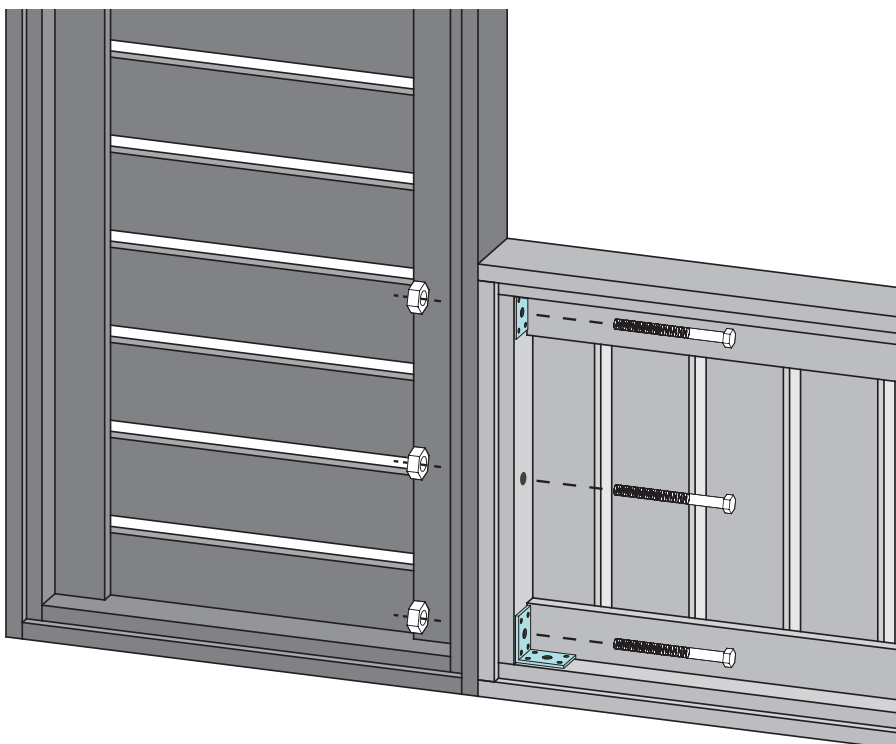
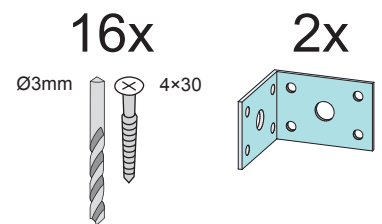
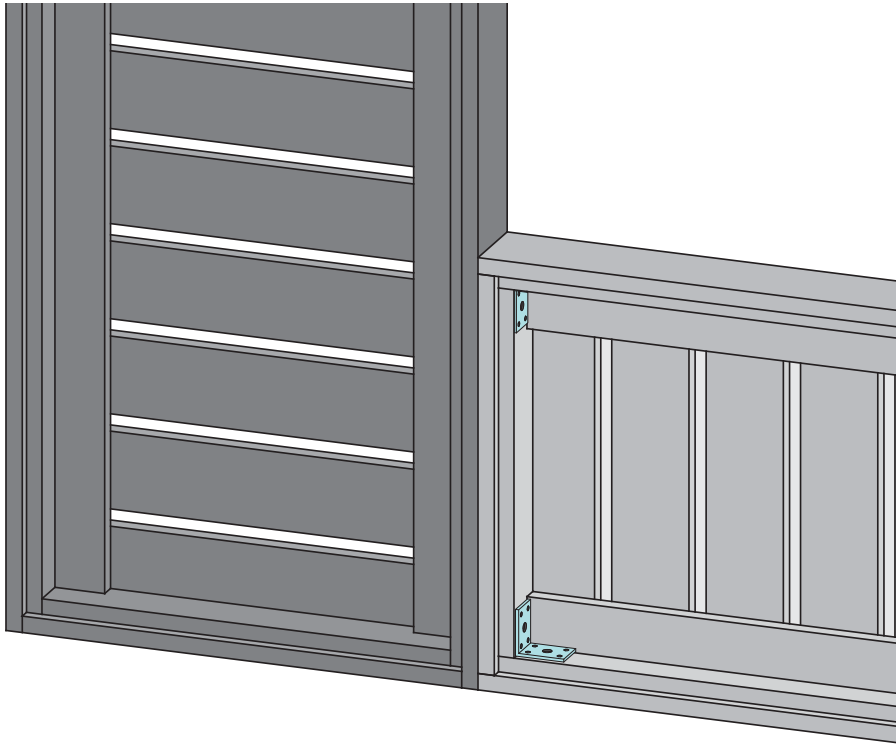

-  Ansicht unten
-  View below
-  Voir ci-dessous
-  Bekijk hieronder
-  Se nedenfor
-  Ver abajo
-  Visualizza sotto
-  Zobrazit níže

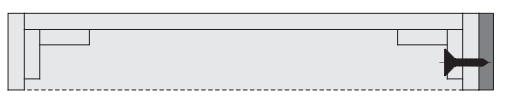
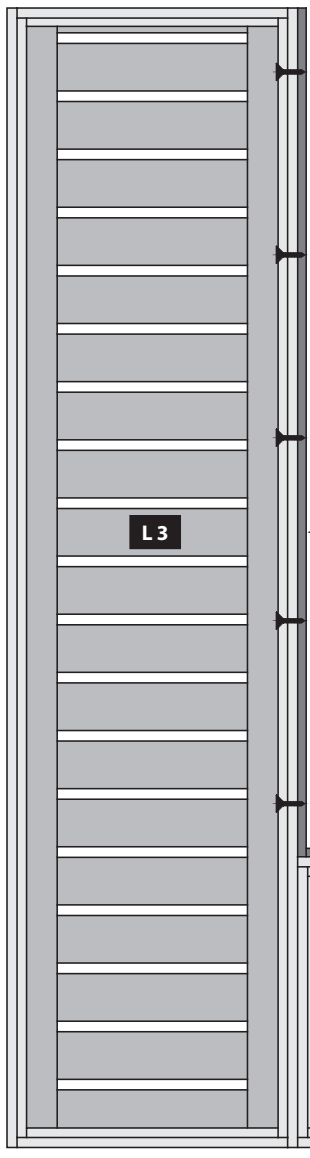
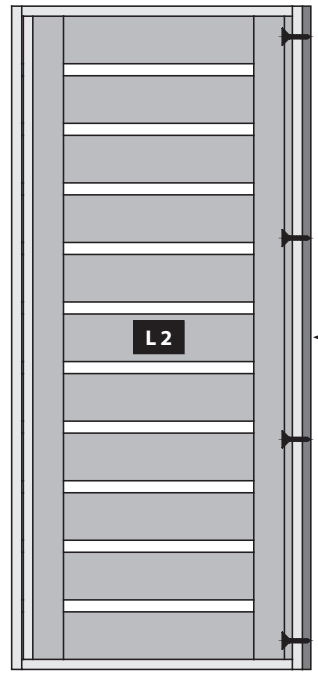

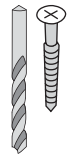
13x
 Ø3mm  4x50

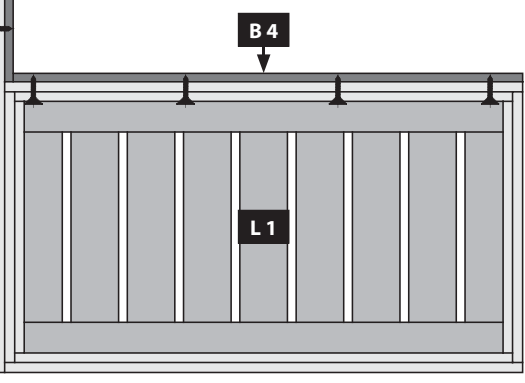

a

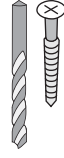

12x

Ø3 mm  4x30

b

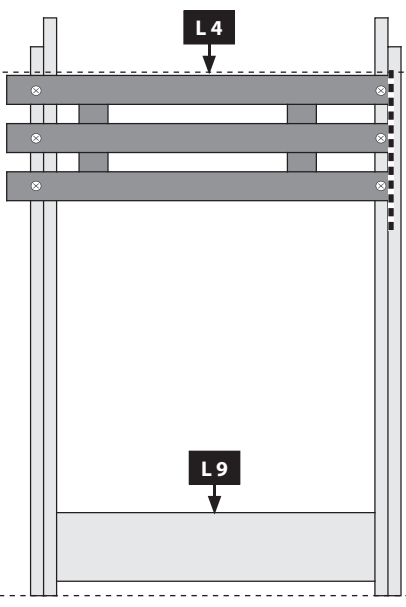

815 mm

-  Bündig!
-  Flush!
-  Affleurement!
-  Gelijk!
-  I flugt!
-  Aras!
-  Combacia!
-  Stejný !

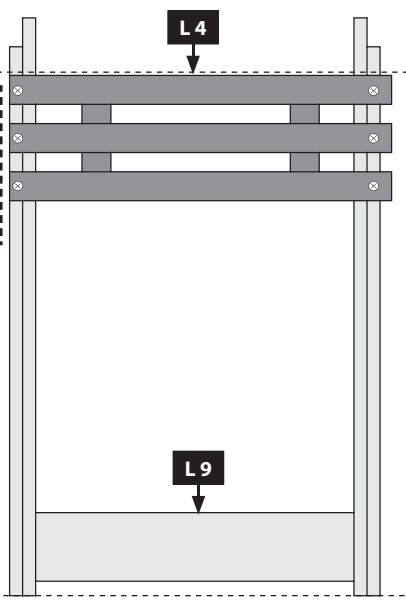

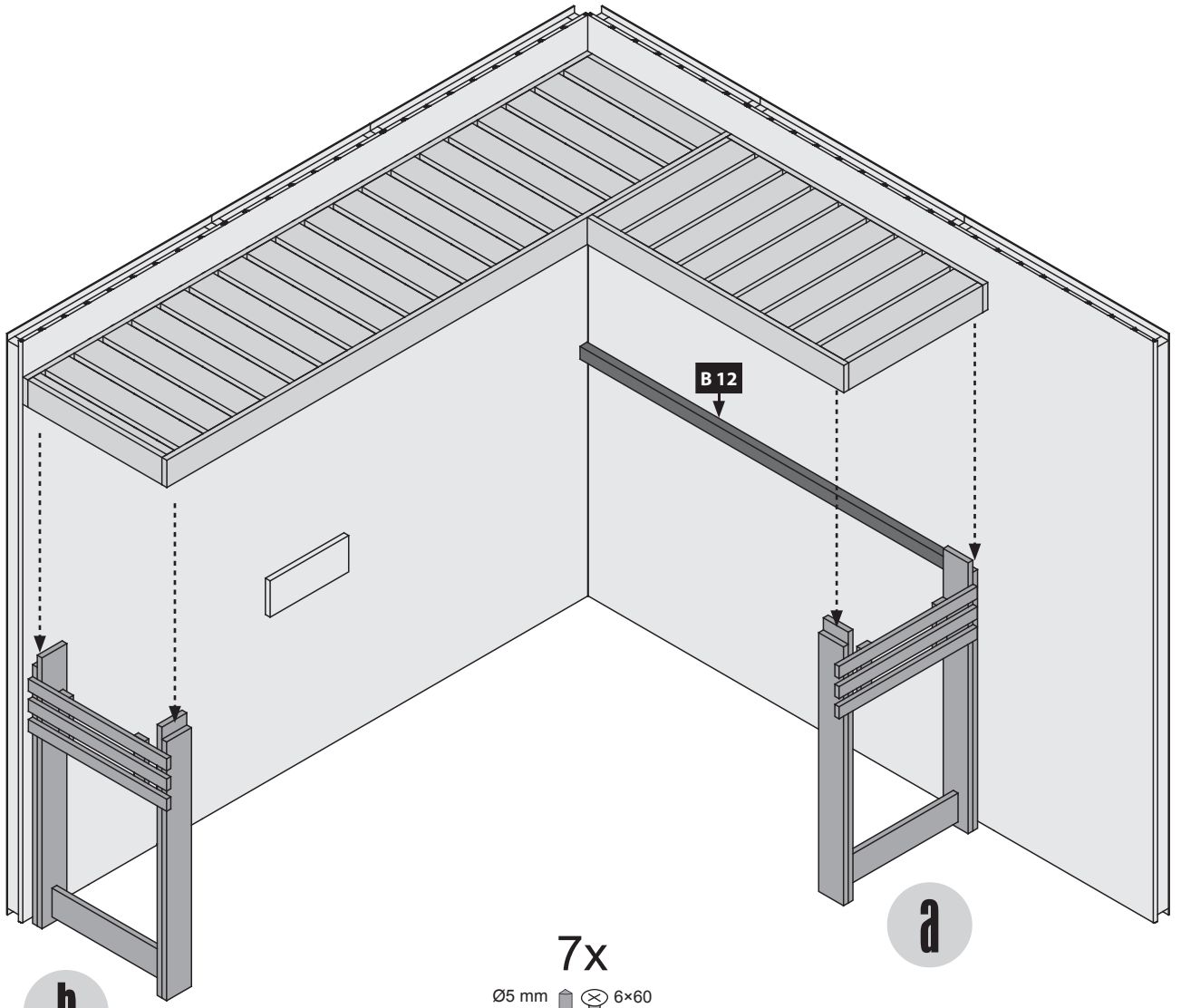

b

a

7x
Ø5 mm 6x60

A technical drawing showing a drill bit with a diameter of 5 mm and a screw with dimensions 6x60 mm. The text '7x' indicates that seven of these screws are used for the installation.

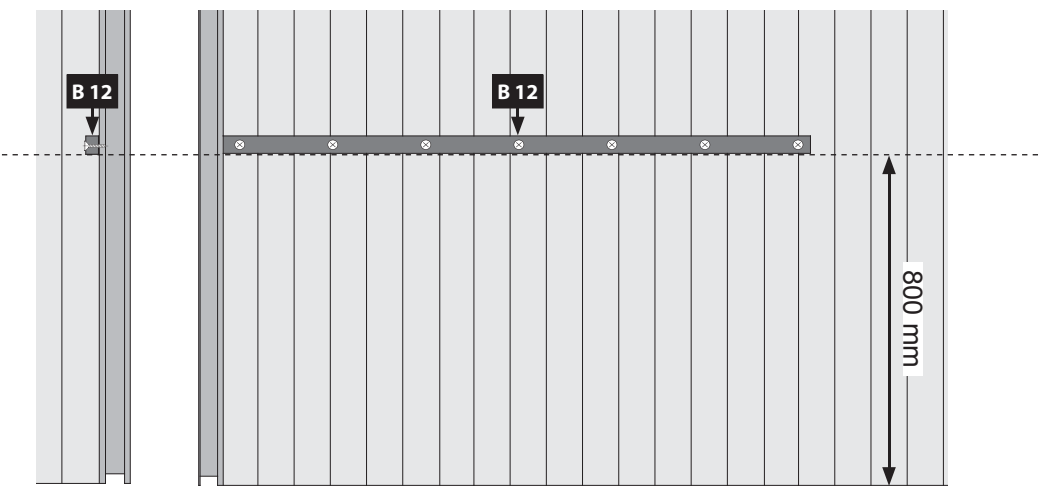

B 12

B 12

800 mm

6x

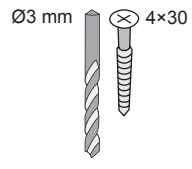

515 mm

-  Bündig!
-  Flush!
-  Affleurement!
-  Gelijk!
-  I flugt!
-  Aras!
-  Combacia!
-  Stejný !

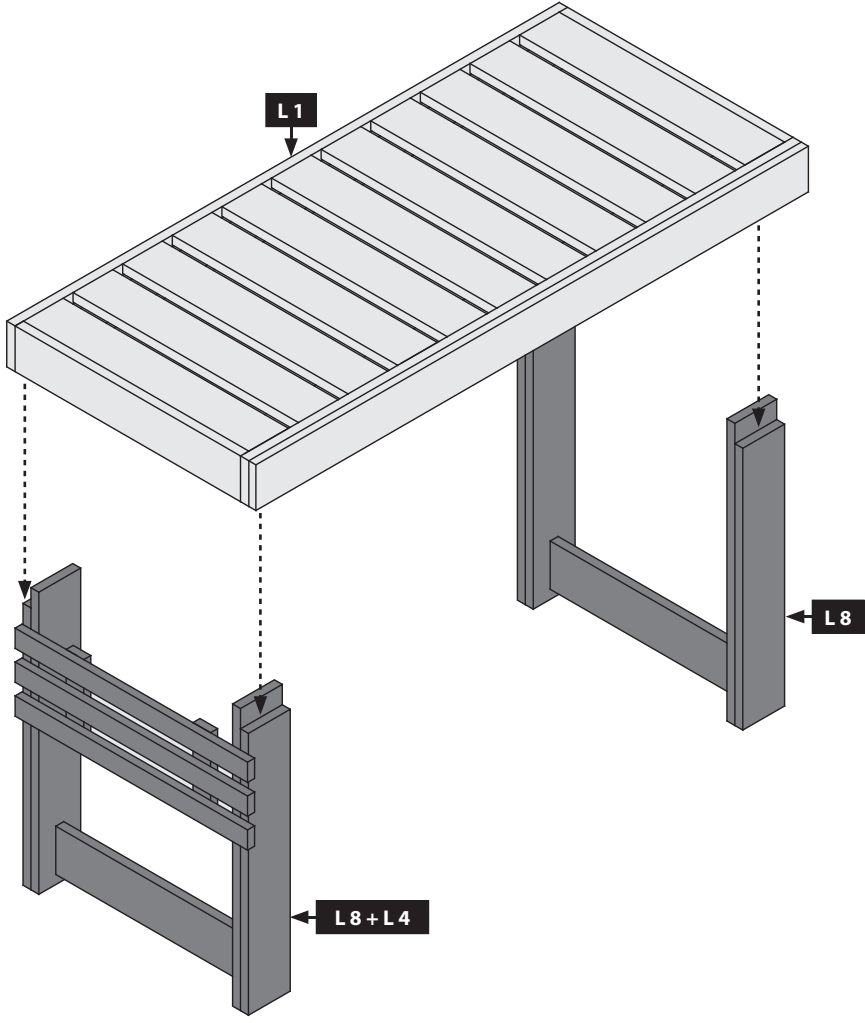
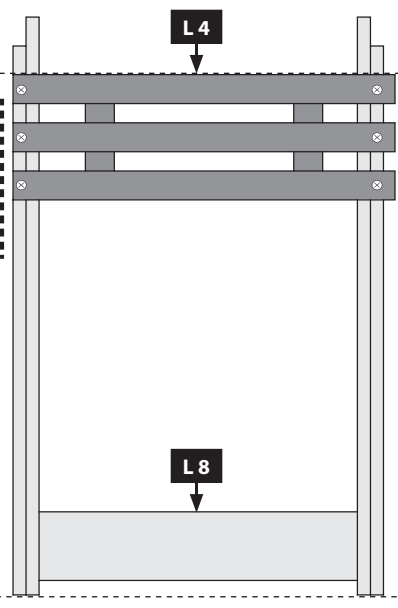

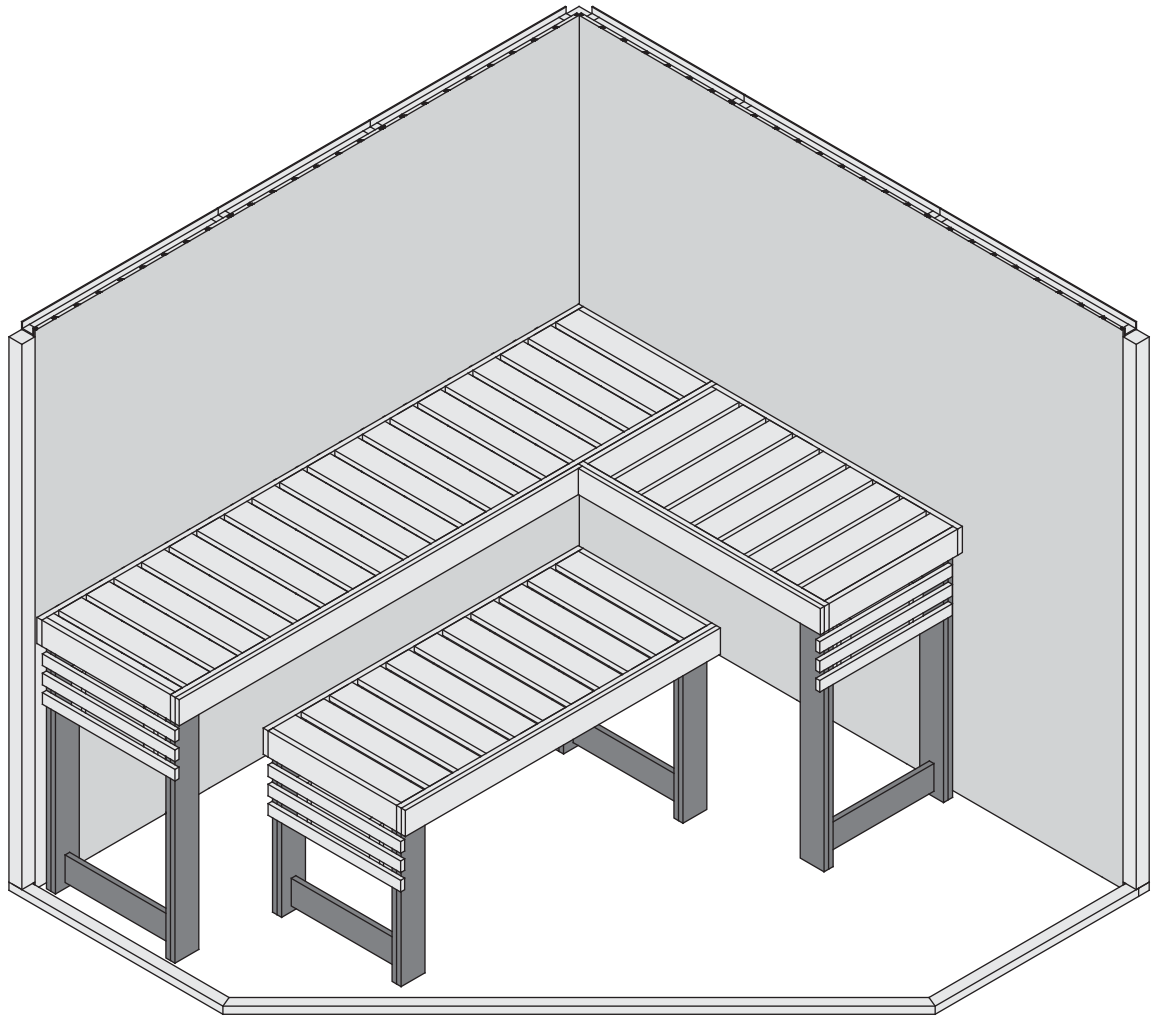

16x

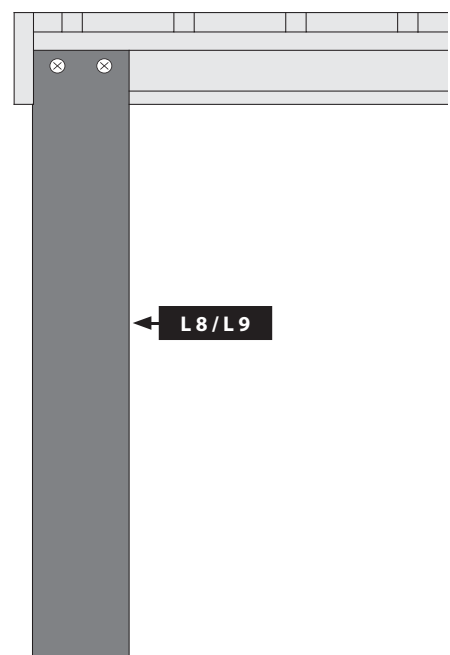
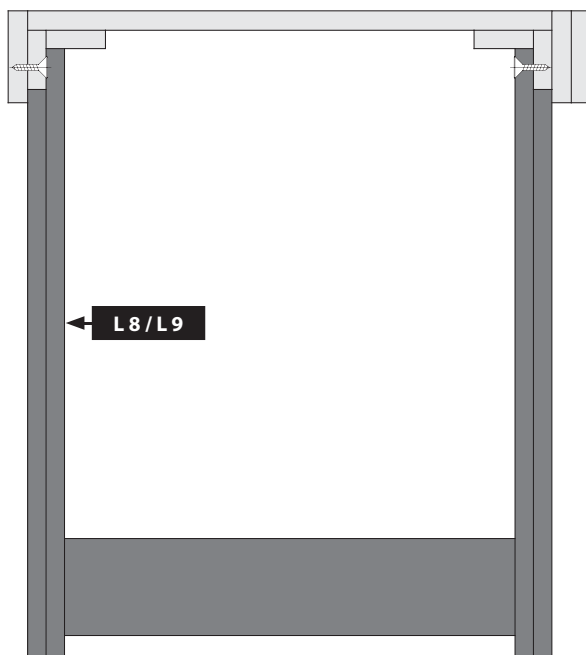
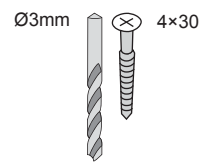

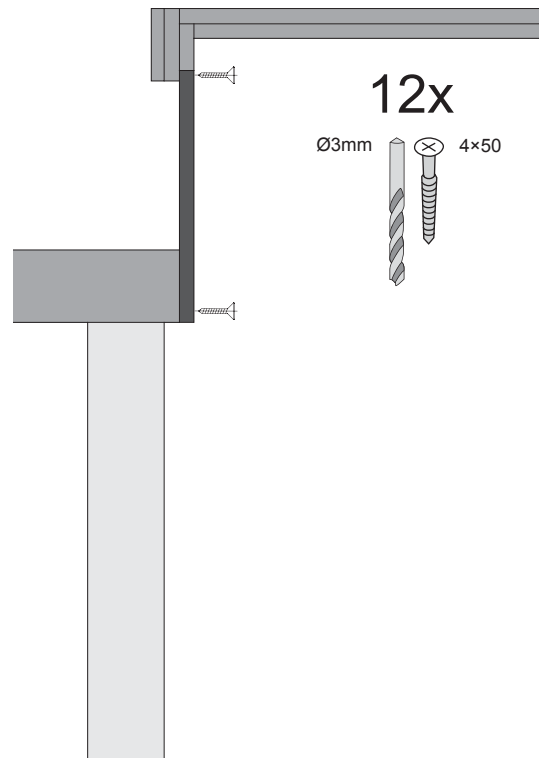
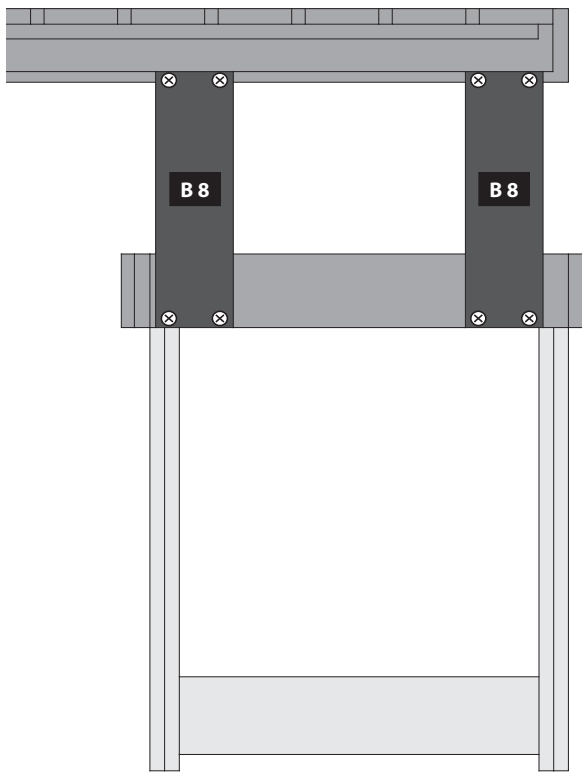
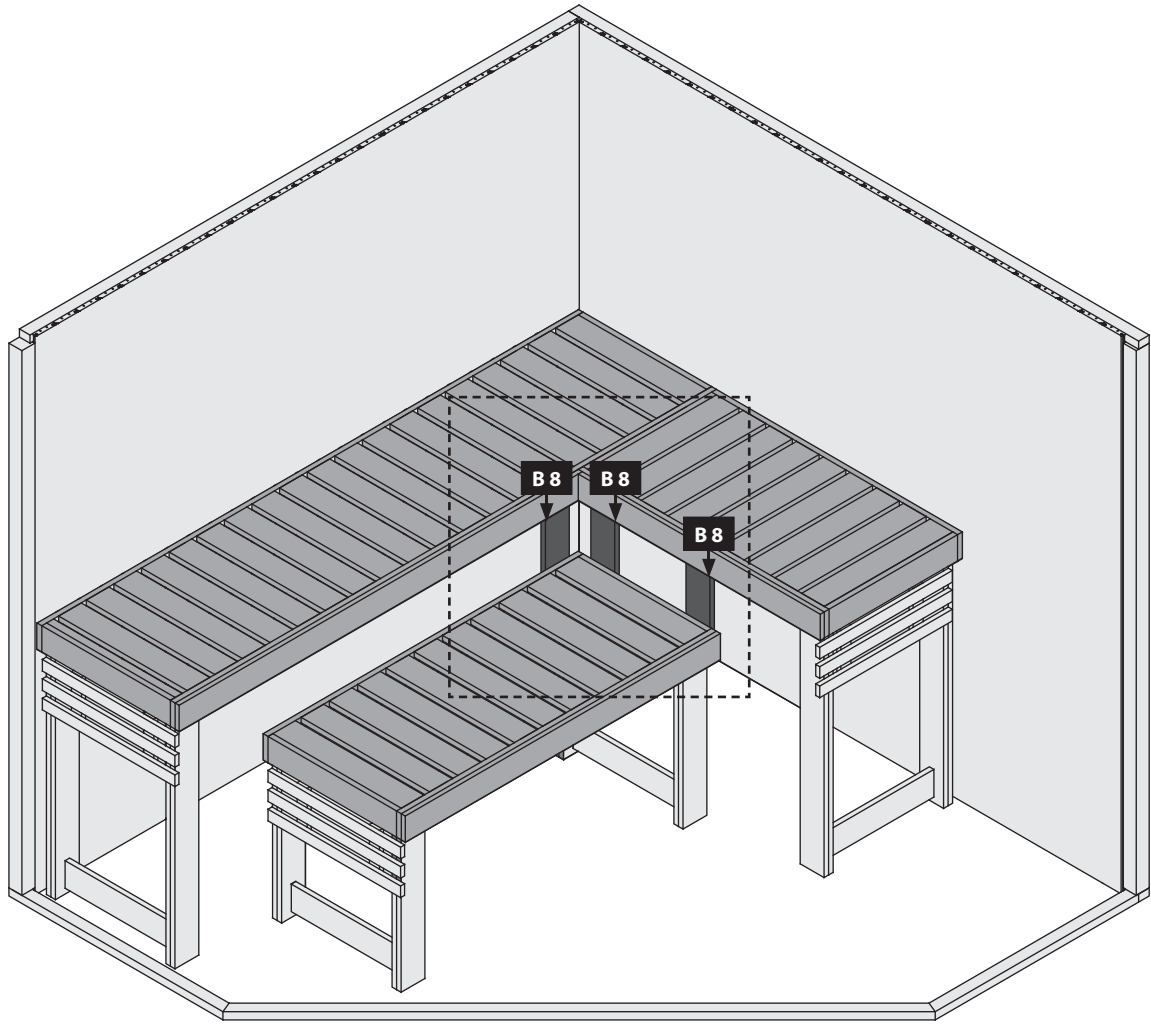

30x

Ø3mm 4x30

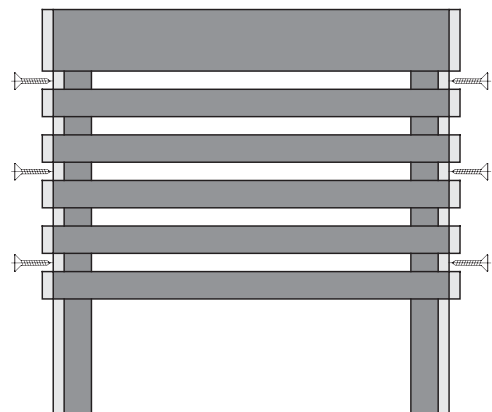
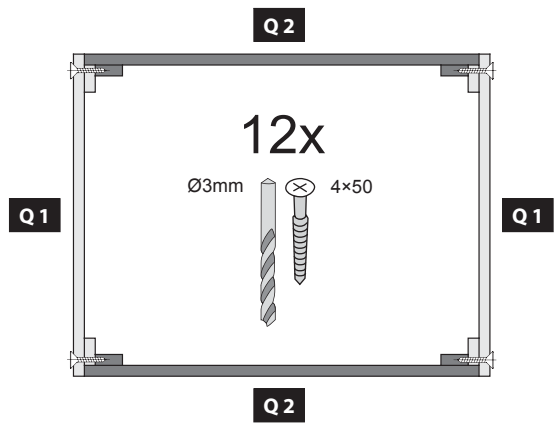
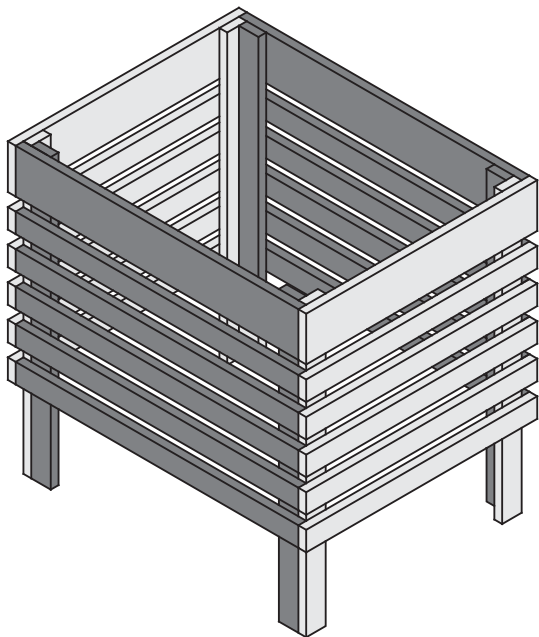
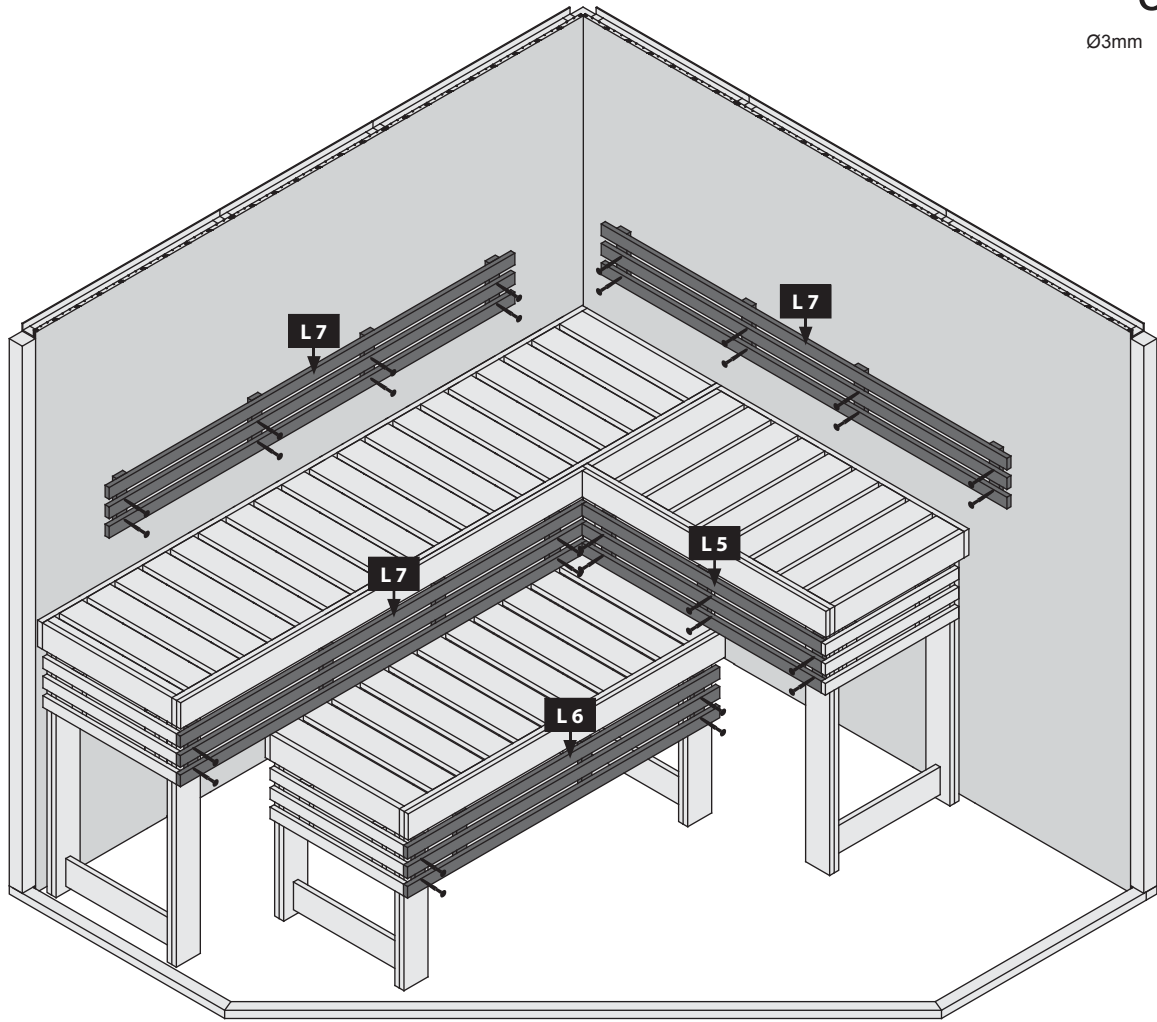
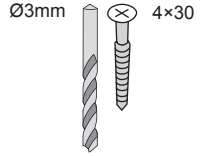

 Kabeldurchführung

 Grommet

 Mise en œuvre du câble

 Kabel implementatie

 Kabel implementering

 Entrada del cable

 ingresso cavi

 kabelová průchodka



26

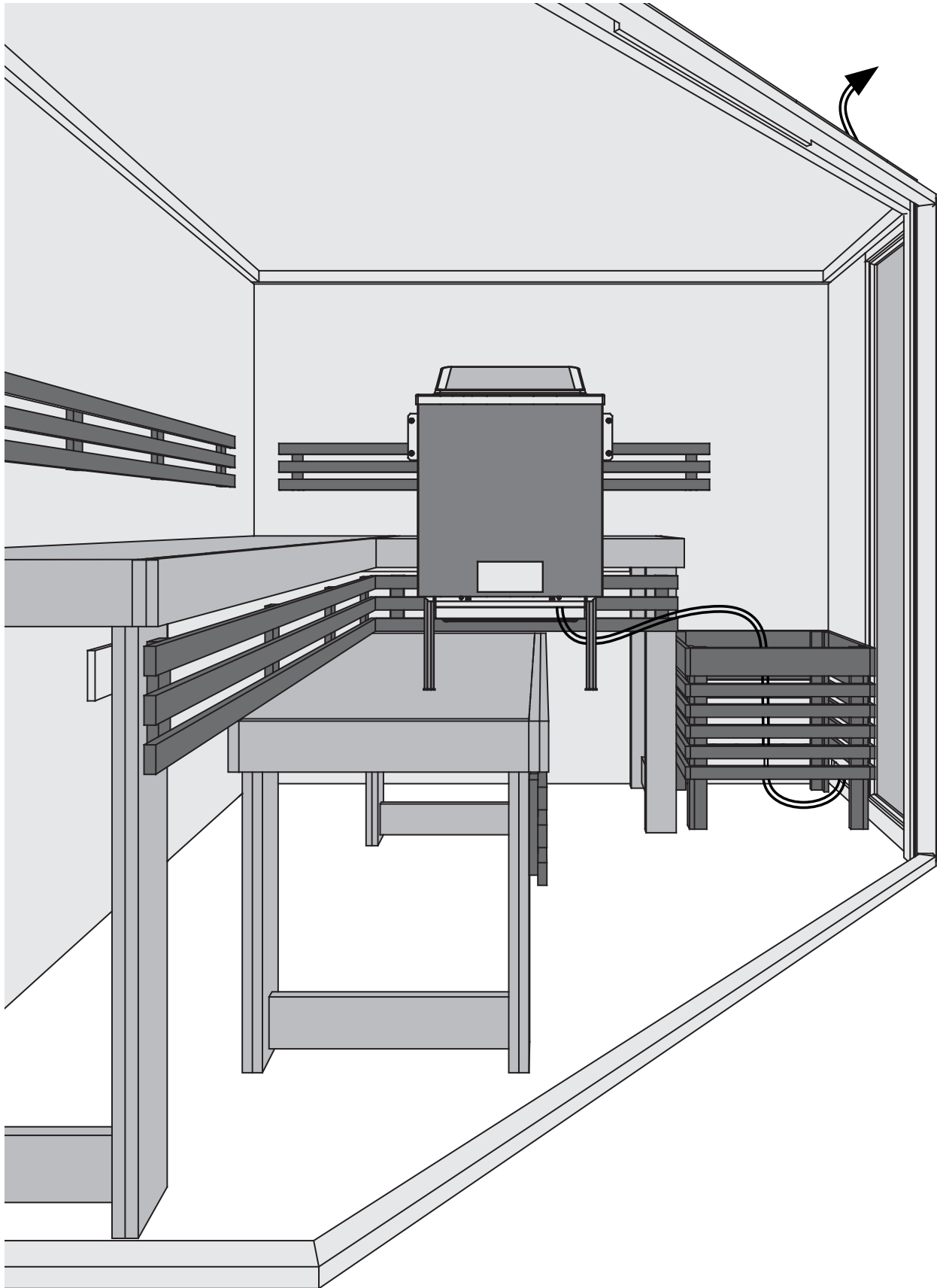

Exemplarische Kabelverlegung



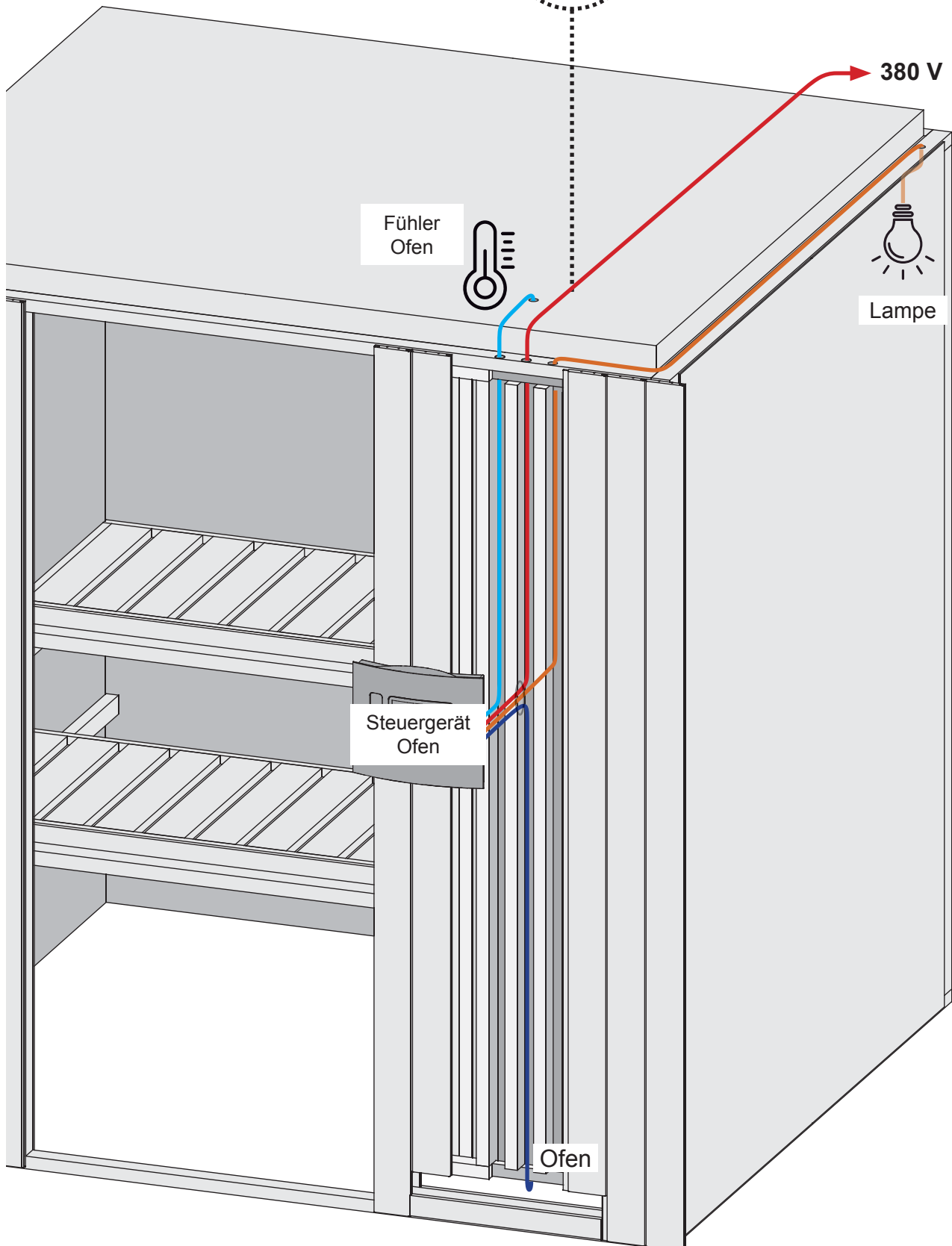
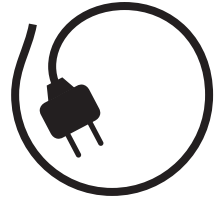
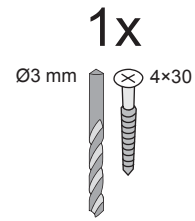

Saunatyp	68mm
Steuerung	extern



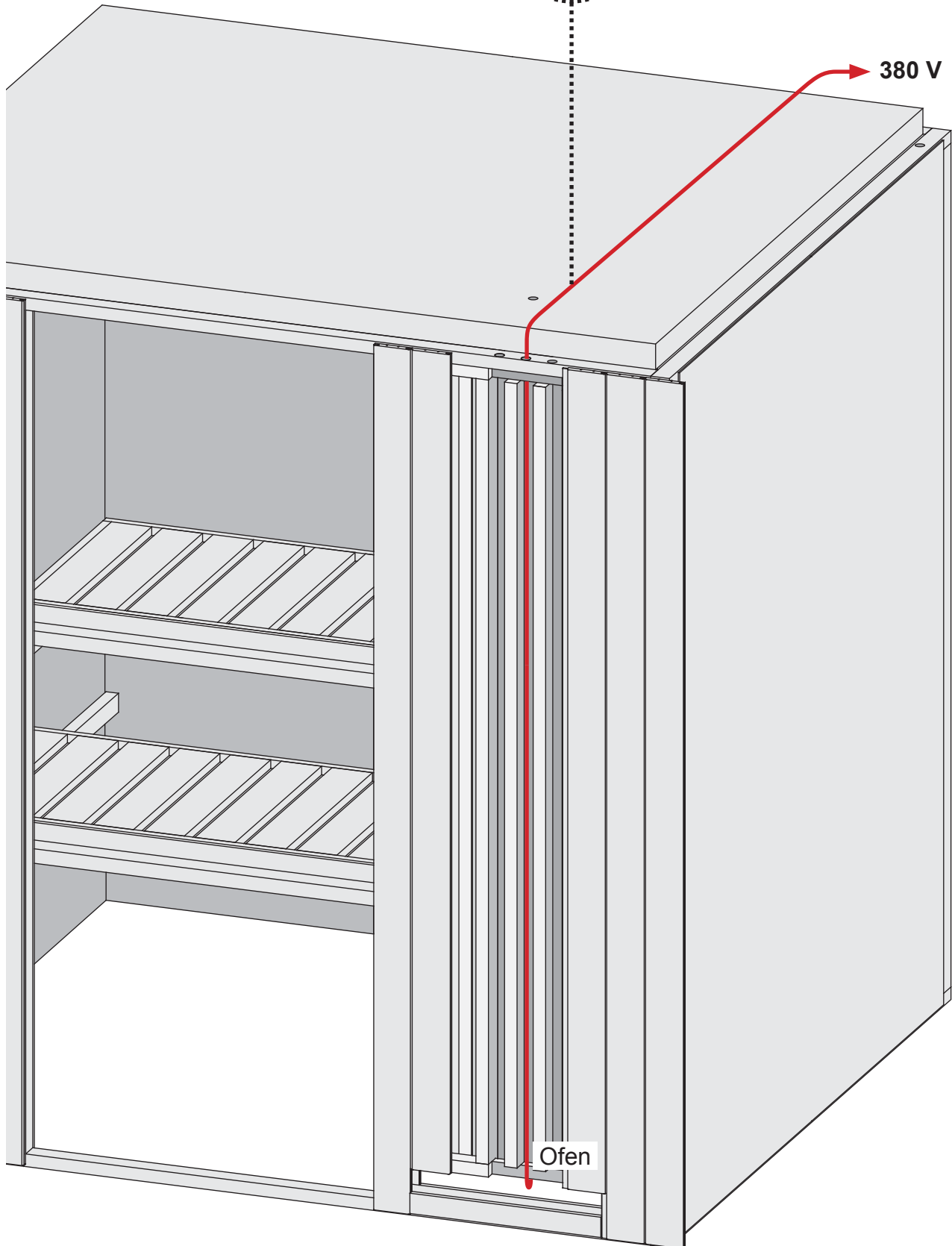
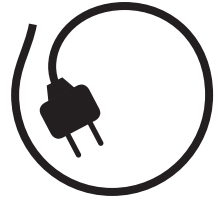
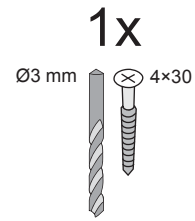



Exemplarische Kabelverlegung

Saunatyp	68mm
Steuerung	integriert



-  Einbau Glastür
-  Installation of glass door
-  Montage porte en verre
-  Montage van de glazen deur

-  Installationsglasdør
-  Montaje de la puerta de cristal
-  Installazione portello di vetro
-  Sauna Instalace dveře

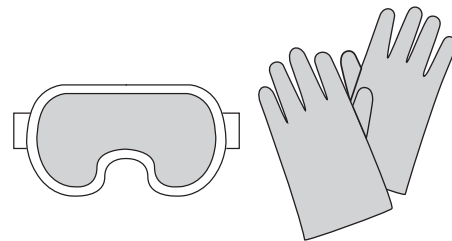

27

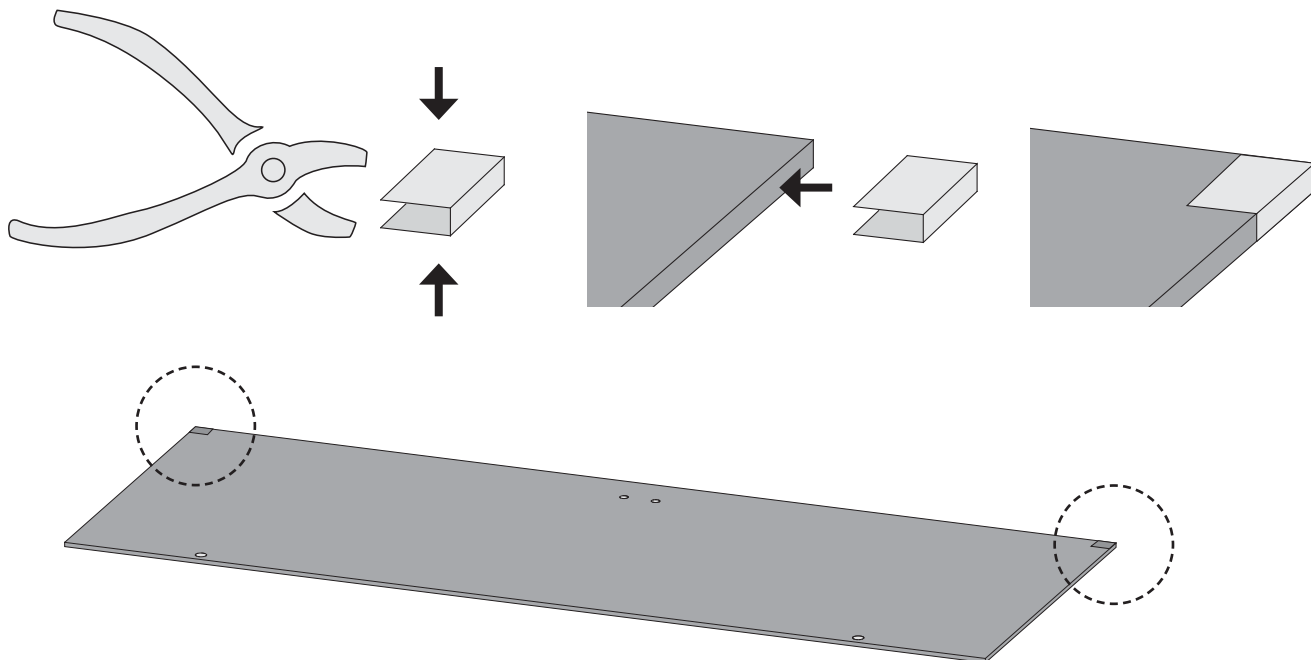



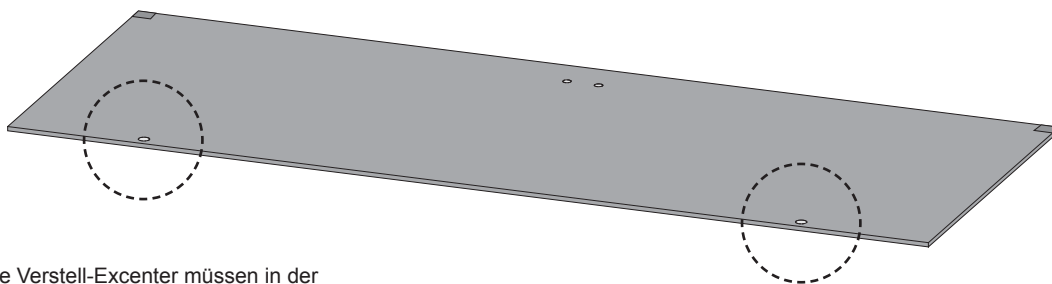



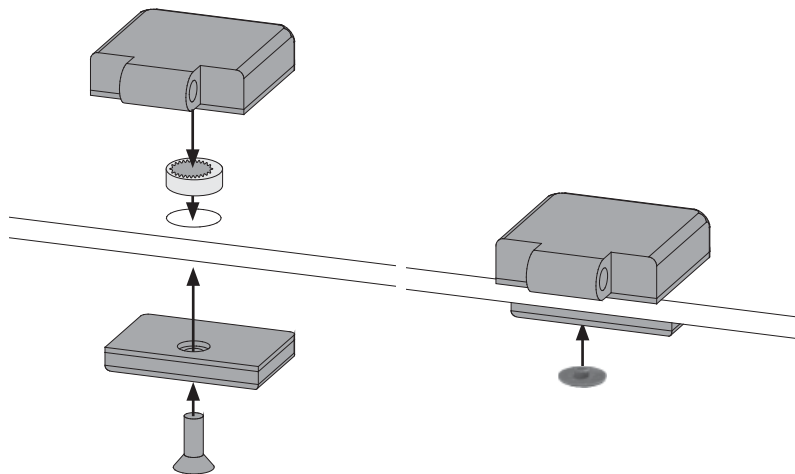

28







-  Alle Verstell-Excenter müssen in der Glasscheibe die gleiche Grundstellung haben
-  All adjustable eccentrics must have the same basic adjustment in the glass panel
-  Tous les excenteurs de positionnement doivent avoir la même position de base dans la vitre
-  Alle excentrische verstelelementen moeten in dezelfde stand in de glasplaat worden geplaatst
-  Alle justeringsexcenter skal have samme grundlæggende position i glasruden
-  Todos los excéntricos regulables tienen que tener la misma posición base en la hoja de cristal
-  Tutti gli eccentrici di regolazione devono avere la stessa posizione base nella lastra di vetro
-  šechny nastavovací podivínů musí mít stejný základní polohy ve skle



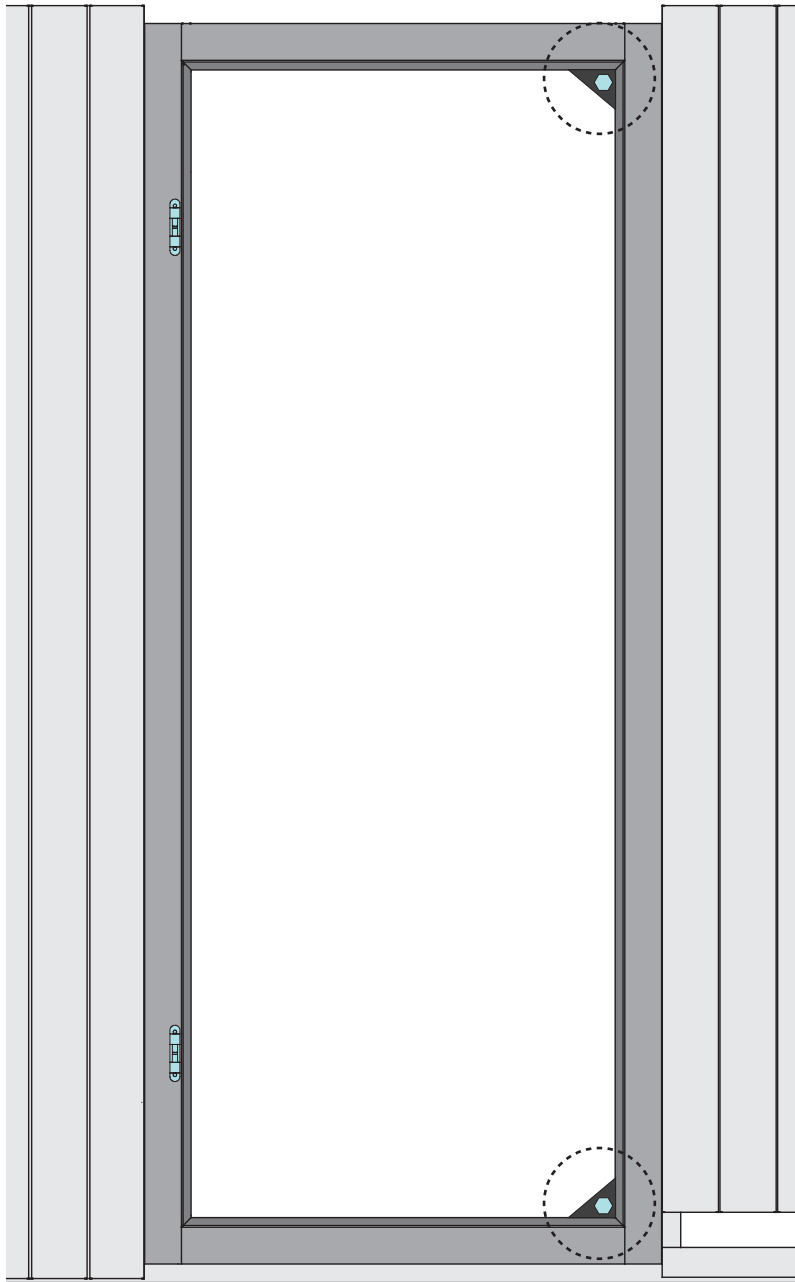
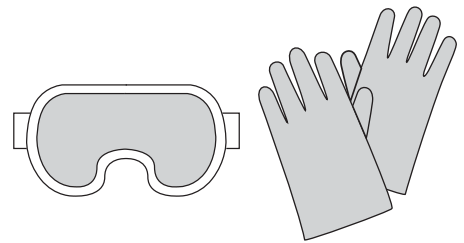



-  Einbau Glastür
-  Installation of glass door
-  Montage porte en verre
-  Montage van de glazen deur





-  Installationsglasdør
-  Montaje de la puerta de cristal
-  Installazione portello di vetro
-  Sauna Instalace dveře



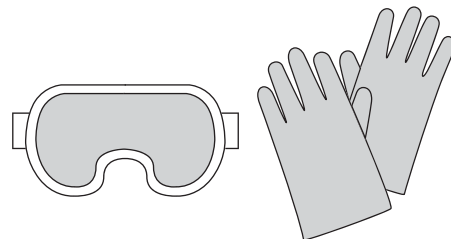



-  Einbau Glastür
-  Installation of glass door
-  Montage porte en verre
-  Montage van de glazen deur

-  Installationsglasdør
-  Montaje de la puerta de cristal
-  Installazione portello di vetro
-  Sauna Instalace dveře



-  Alle Verstell-Excenter müssen in der Glasscheibe die gleiche Grundstellung haben
-  All adjustable eccentrics must have the same basic adjustment in the glass panel
-  Tous les excenteurs de positionnement doivent avoir la même position de base dans la vitre
-  Alle excentrische verstelelementen moeten in dezelfde stand in de glasplaat worden geplaatst

-  Alle justeringsexcenter skal have samme grundlæggende position i glasruden
-  Todos los excéntricos regulables tienen que tener la misma posición base en la hoja de cristal
-  Tutti gli eccentrici di regolazione devono avere la stessa posizione base nella lastra di vetro
-  šechny nastavovací podivínů musí mít stejný základní polohy ve skle

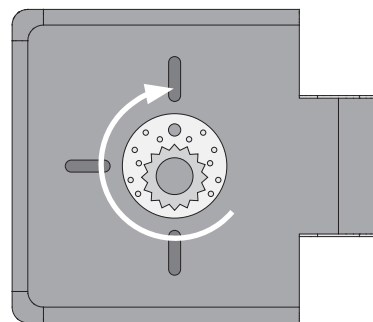
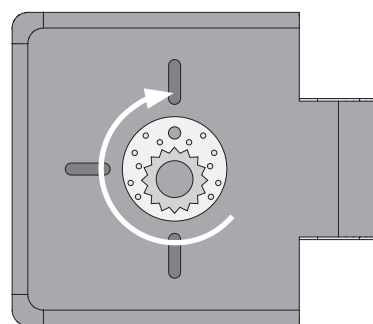
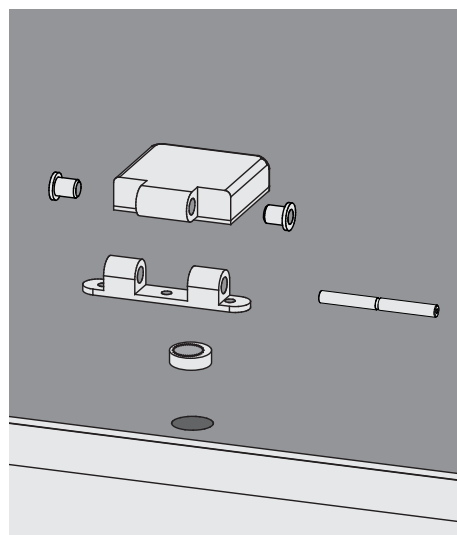
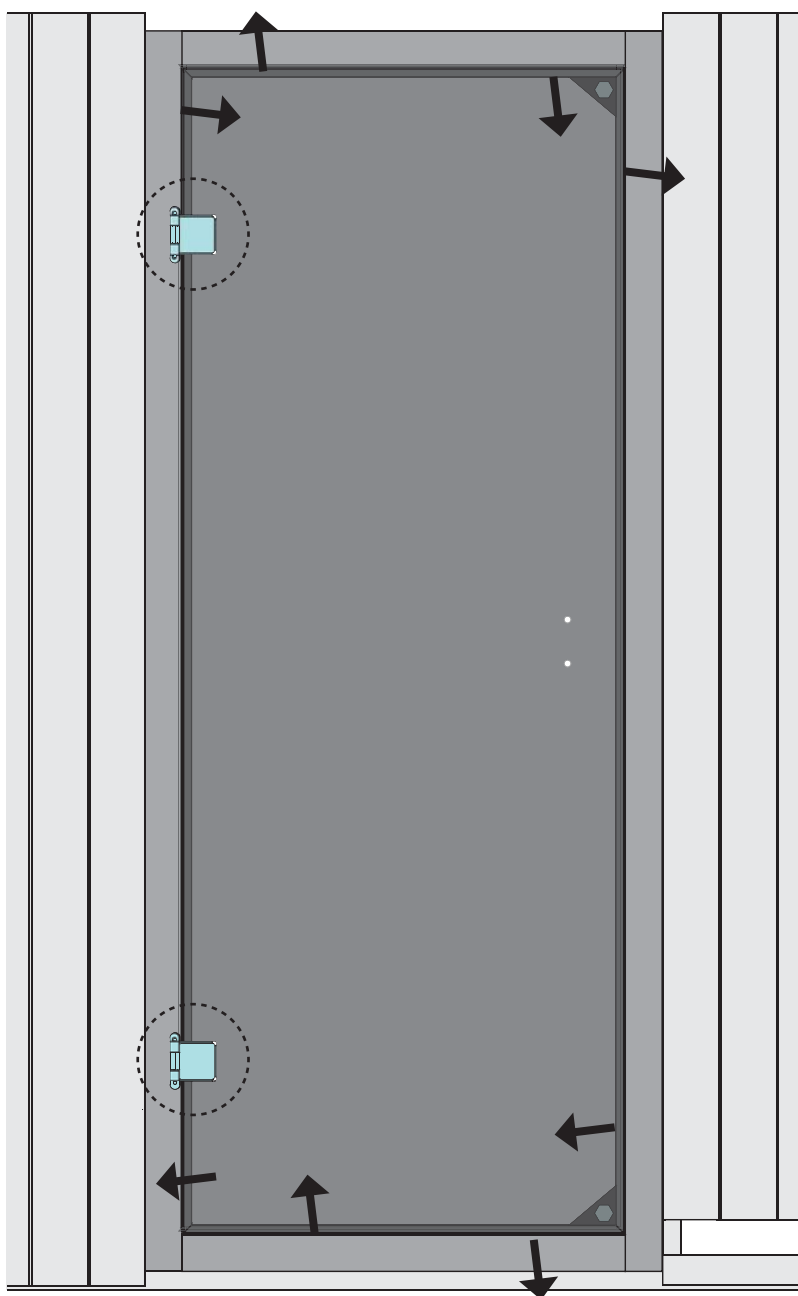

1.

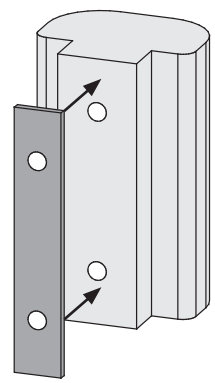

2.

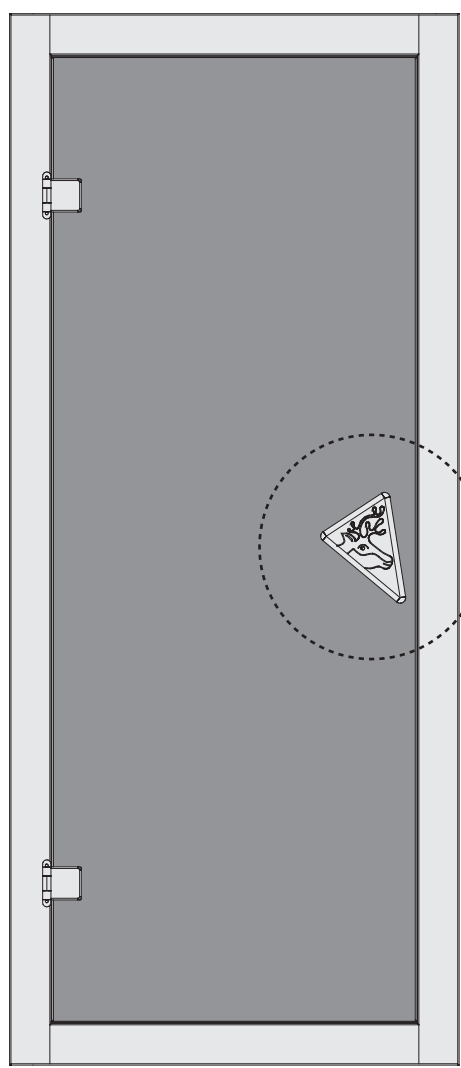
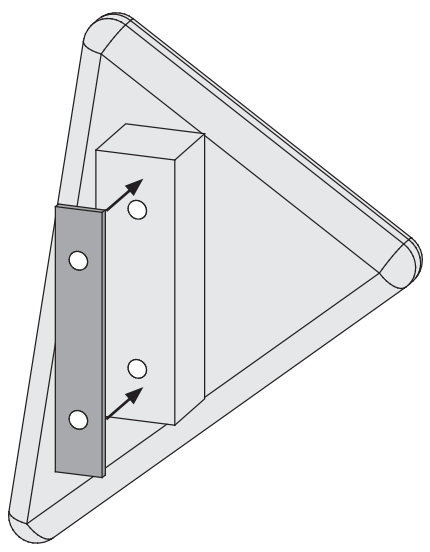

3.

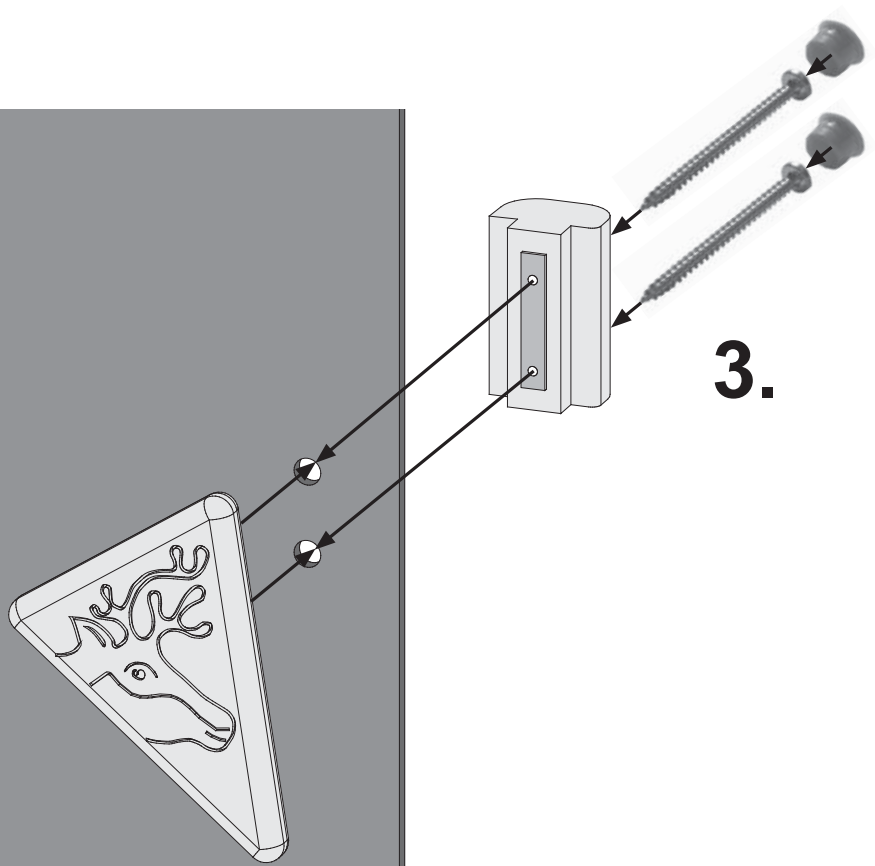

 Installation TÜV-Schild

 Installatie TÜV Shield

 Instalace TÜV Shield

 Installation TÜV Shield

 Installazione TÜV Shield

 Namestitev TÜV tablice

 Installation TÜV Shield

 Instalación TÜV Escudo

01

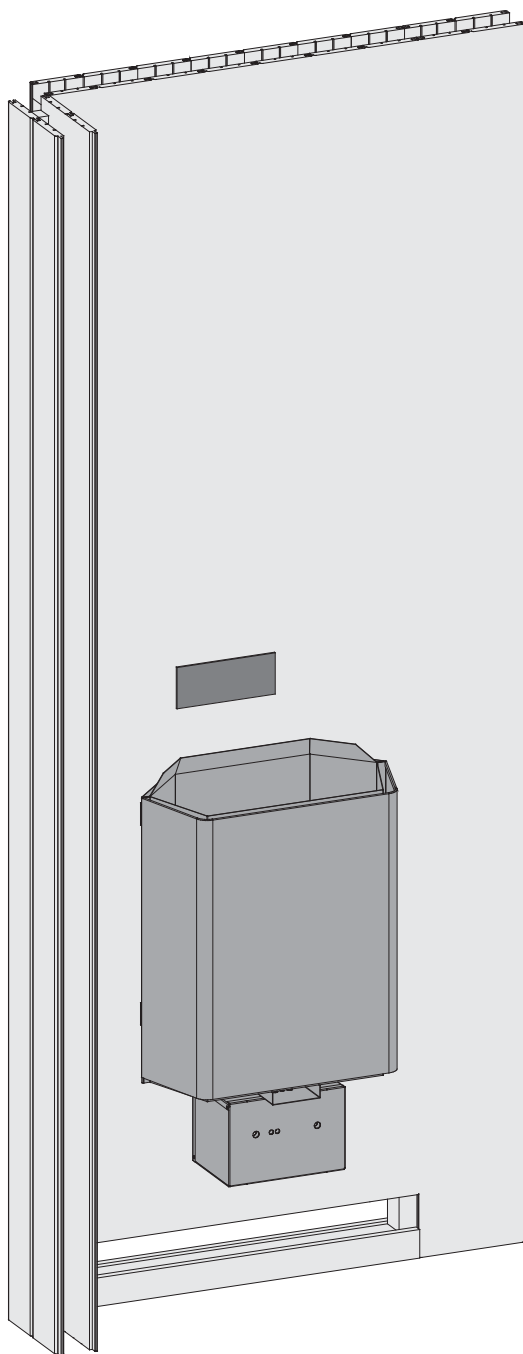



 Entfernen Sie die Schutzfolie vom beiliegenden TÜV-Schild. Lassen Sie den Saunaofen von einem zugelassenen Elektrofachmann anschließen. Dieser markiert den installierten Ofen auf dem TÜV-Schild. Bringen Sie das TÜV-Schild an einer gut sichtbaren Stelle über dem Ofen an.

 Remove the protective film from the accompanying Participate Schild. Lassen connecting the heater by a licensed electrician. This marks the installed furnace on the TÜV sign. Attach the TÜV sign at a conspicuous place on the stove.

 Retirez le film protecteur de l'accompagnant Participer Schild. Lassen raccorder l'appareil par un électricien agréé. Ceci marque le four installé sur le signe TÜV. Fixer le signe de TÜV à un endroit bien en vue sur le poêle.

 Verwijder de beschermfolie van de begeleidende Deelnemen Schild. Lassen het aansluiten van de kachel, door een erkende elektricien. Dit markeert de geïnstalleerde oven op het TÜV teken. Bevestig de TÜV teken op een opvallende plaats op het fornuis.

 Rimuovere la pellicola protettiva dal accompagna Partecipa Schild. Lassen collegando il riscaldatore da un elettricista qualificato. Questo segna il forno installato sul segno TÜV. Fissare il segno TÜV in un luogo ben visibile sulla stufa.

 Retire la película protectora de la Schild. Lassen acompaña Participar conectar el calentador por un electricista autorizado. Esto marca el horno instalado en el signo TÜV. Coloque el cartel de TÜV en un lugar visible en la estufa.

02

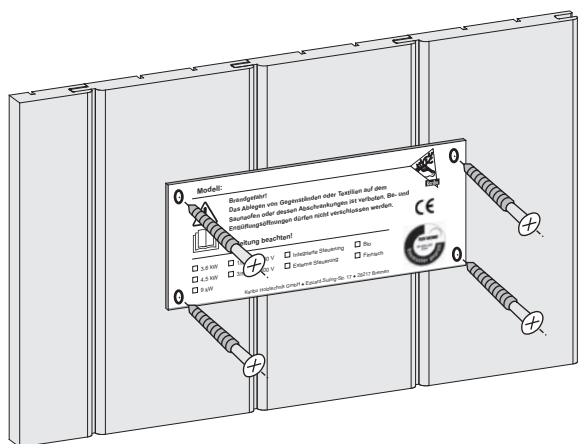

 Odstraňte ochrannou fólii z doprovodného Hlavní Schild. Lassen připojení ohříváče licencovaným elektrikář. Toto označí Instalovaný pec na znamení TÜV. Připevněte znamení TÜV na dobře viditelném místě na sporáku.

 S priložene tablice odstranite zaščitno folijo. Peč savne naj priključi usposobljeno osebnje, ki inštalirano peč označi na TÜV tablici. Tablico namestite na vidno mesto peči.



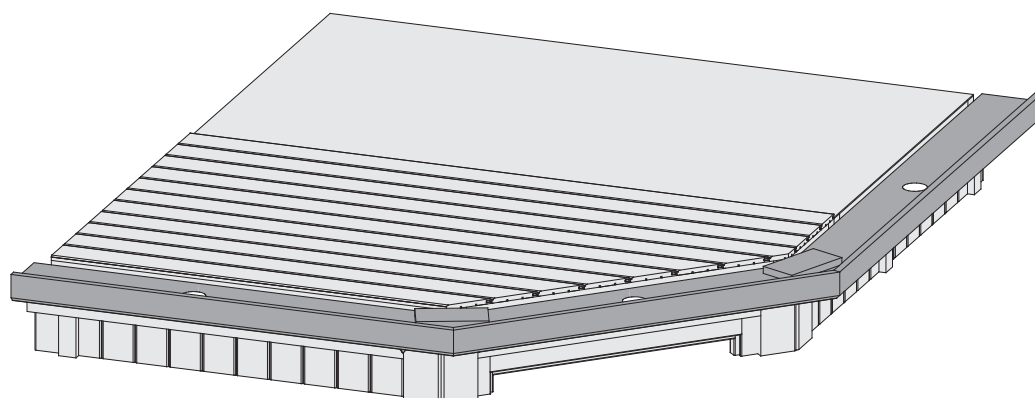

64227





-  **Aufbauanleitung**
-  **Building Instructions**
-  **notice de montage**
-  **montagehandleiding**
-  **Montagevejledning**
-  **Instrucciones de construcción**
-  **Istruzioni per il montaggio**
-  **Montážní návod**
-  **Navodila za sestavljanje**

 Vergleichen Sie zuerst die Material-liste mit Ihrem Paketinhalt! Bitte haben Sie Verständnis, dass Beanstandungen nur im nicht aufgebauten Zustand bearbeitet werden können!

 First compare the list of materials with your package contents! Please understand that complaints can be processed in the non-built status only!

 Commencez par comparer la liste du matériel avec le contenu de votre paquet! Sachez que nous traitons uniquement les réclamations concernant le matériel à l'état non monté!

 Vergelijk eerst de lijst van materialen met de inhoud van uw pakket! Reclamaties kunnen alleen in behandeling worden genomen zolang de onderdelen nog niet zijn gemonteerd!

 Start med at kontrollere materialelisten med indholdet af den leverede pakke! Vi gør venligst opmærksom på at reklamationer kun kan behandles for materialer som ikke er blevet bearbejdet!

 En primer lugar, compare la lista de material con el contenido del paquete. Rogamos entienda que las reclamaciones sólo pueden ser tramitadas antes de montar el objeto!

 Confrontate questa distinta materiali prima con il contenuto del pacchetto! Vi preghiamo di comprendere che eventuali reclami possono essere accolti solo prima del montaggio!

 Nejprve přezkontrolujte obsah balení podle materiálového listu! Mějte pochopení pro to, že případnou reklamaci se můžeme zabývat pouze tehdy, když díly nebudou smontované! Za pomoci tohoto seznamu můžete jednotlivé díly přiřadit k montážnímu návodu.

 Najprej primerajte zoznam materialov z vebino vašega paketa! Upoštujte, da lahko pritožbe obravnavamo le v nesestavljenem stanju!

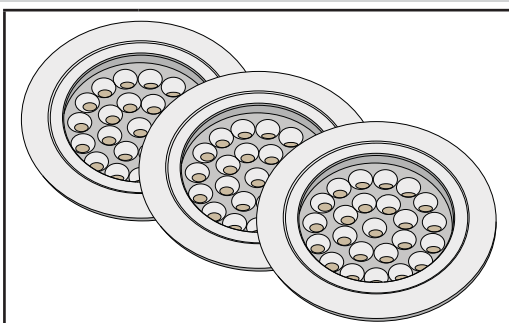
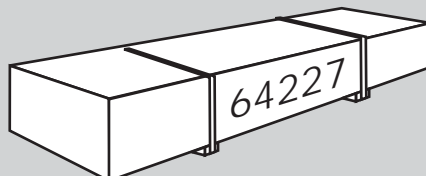

1 x ID 70565

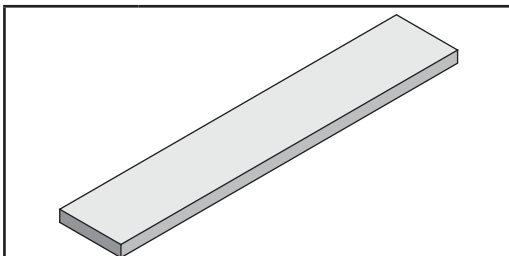

2 x A1 200 x 95 x 18mm ID 28440

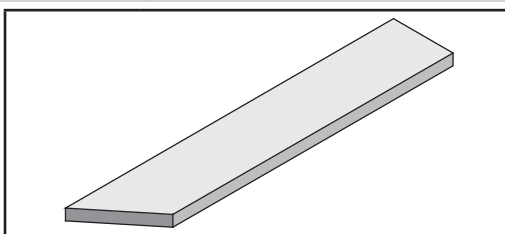

2 x B1 1730 x 140 x 26mm ID 47476

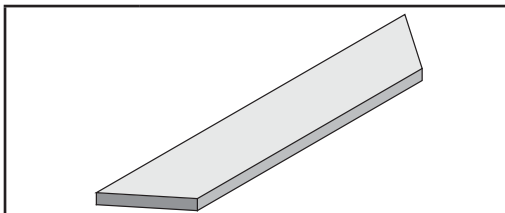

1 x C1 1045 x 140 x 26mm ID 21117

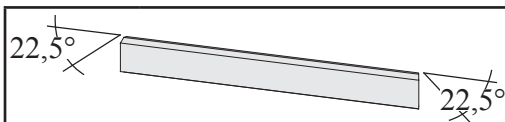

1 x D1 1060 x 58 x 18mm ID 47473

2 x D2 1790 x 58 x 18mm ID 64262

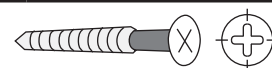

30 x 4 x 40 mm ID 21925

50 x 4 x 50 mm ID 3688

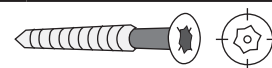

20 x 4,5 x 40 mm ID 26285

30 x ID 26116



01

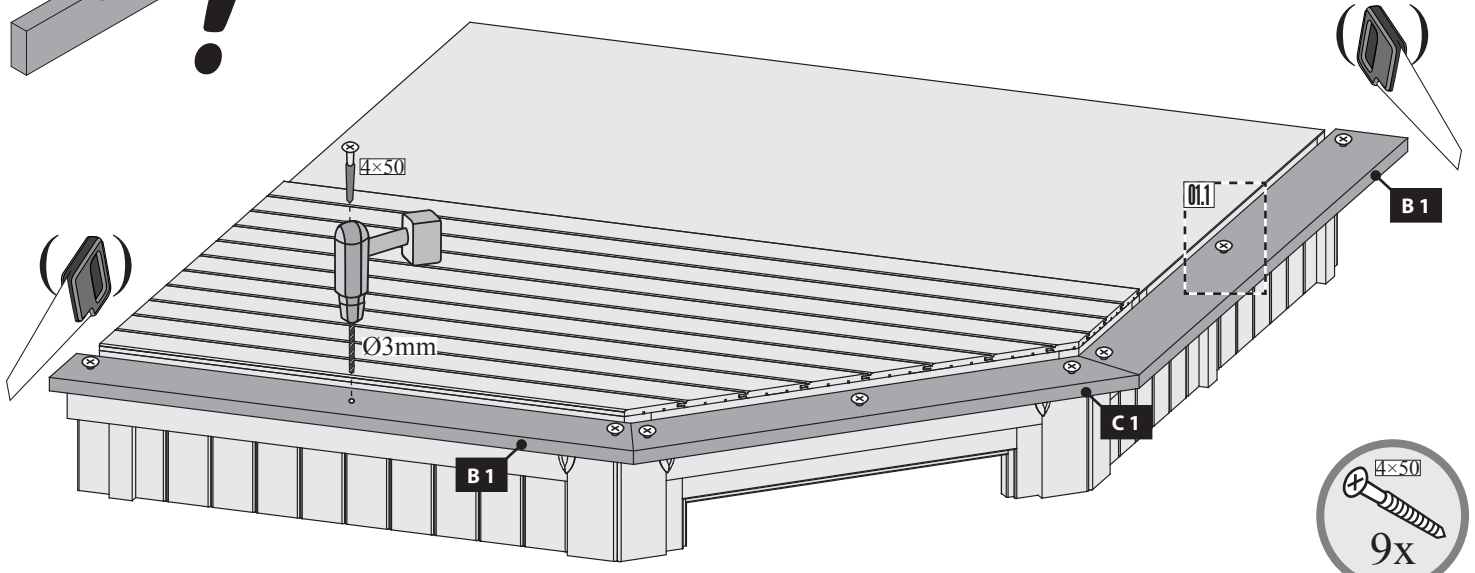
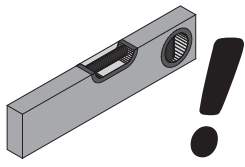

01.1

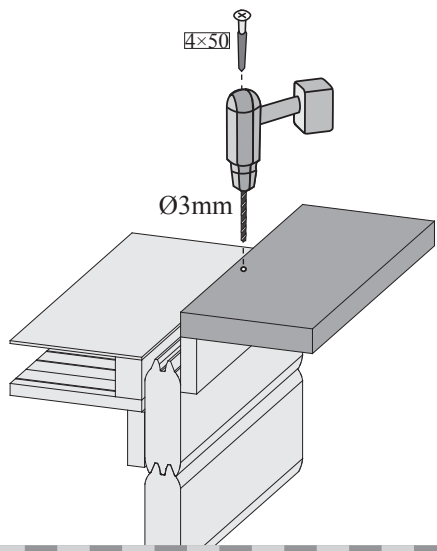

02.1

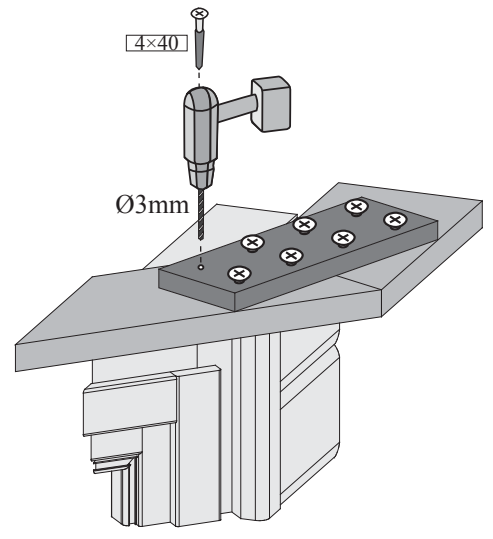

02

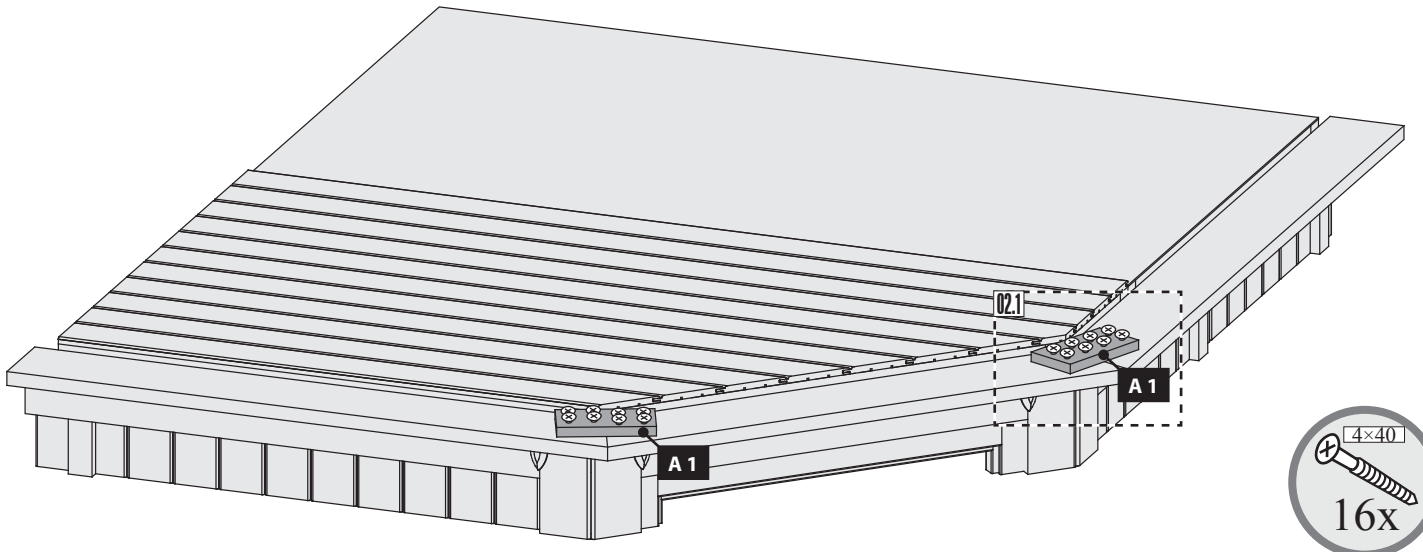

03

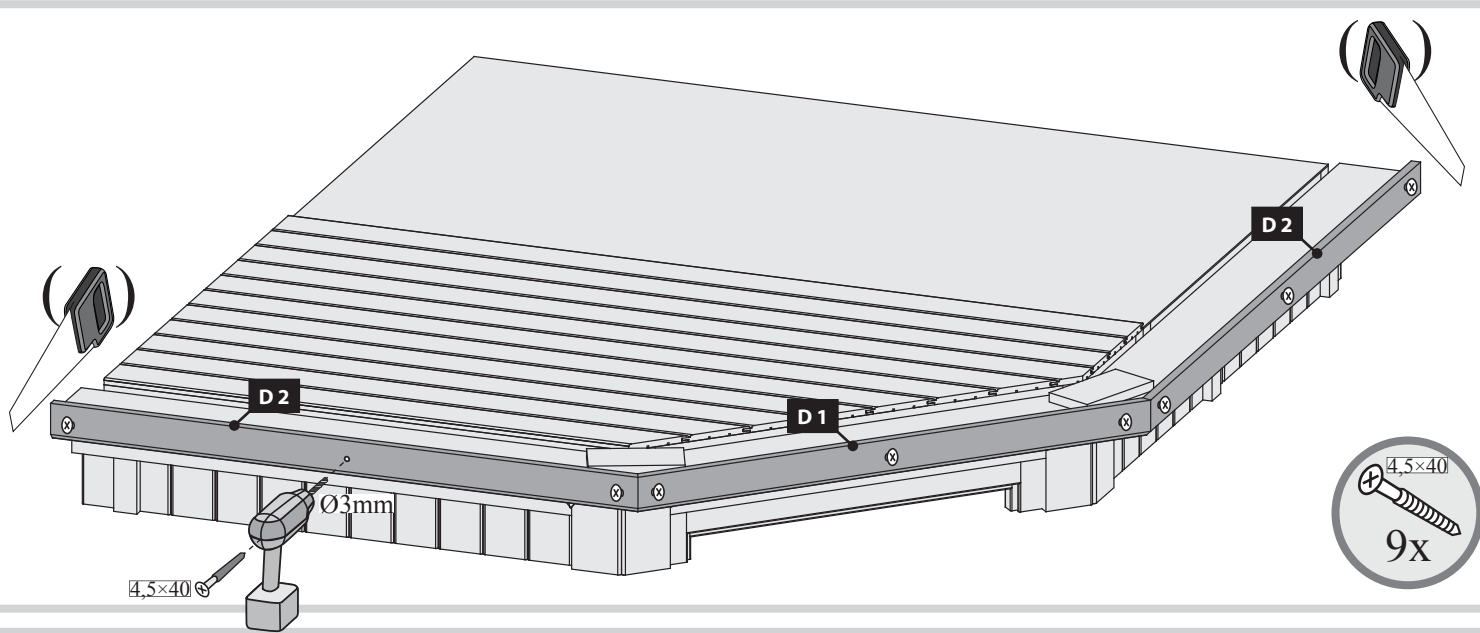

04

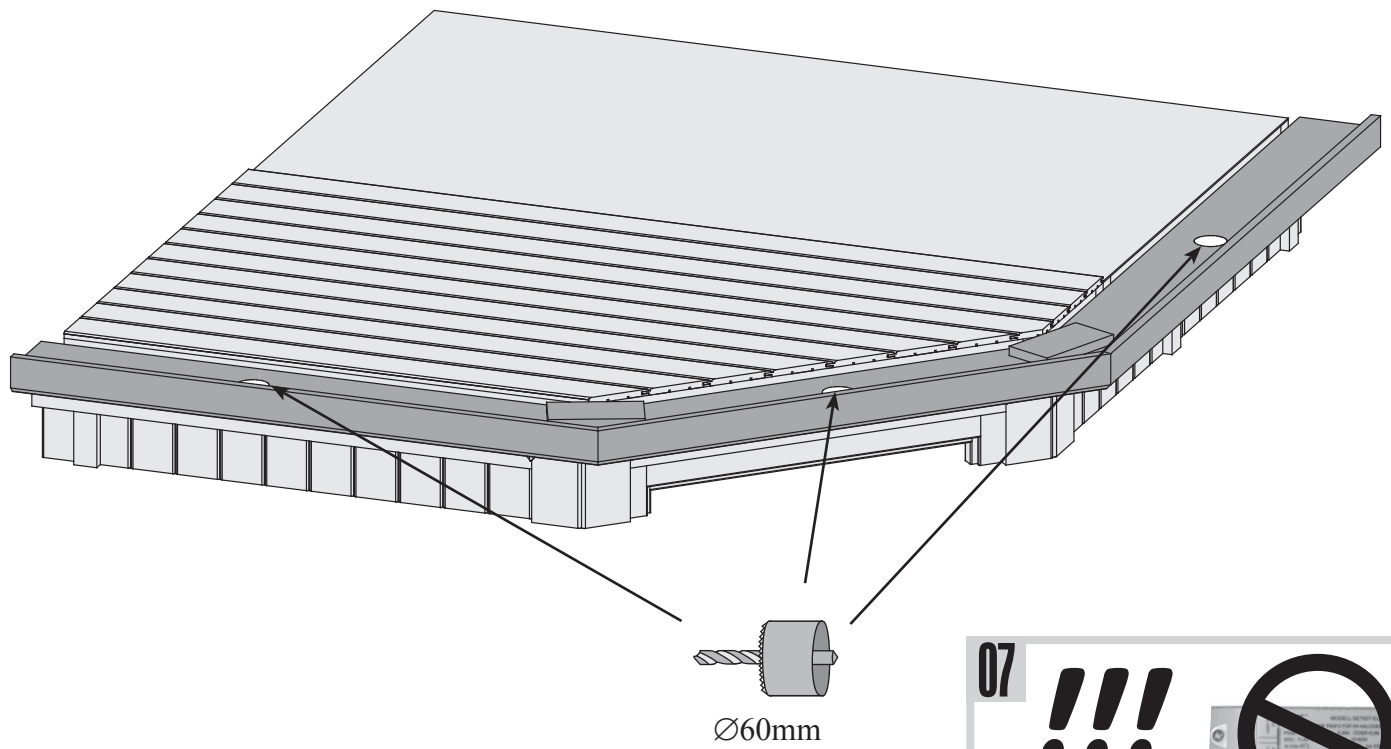

05

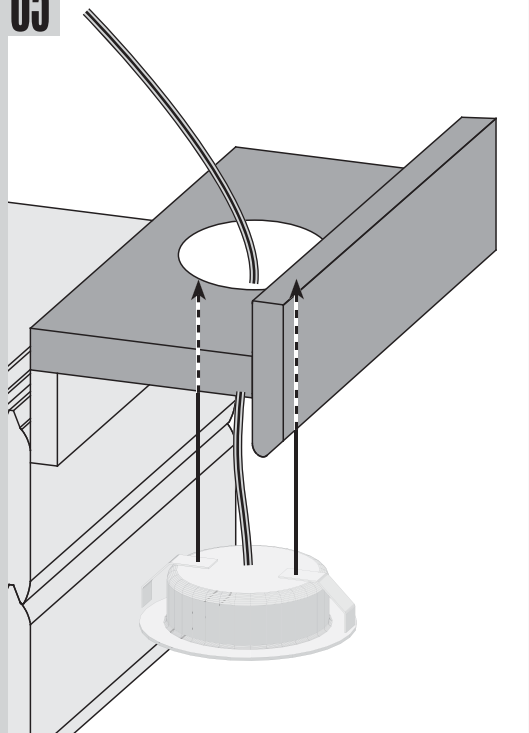

06



07

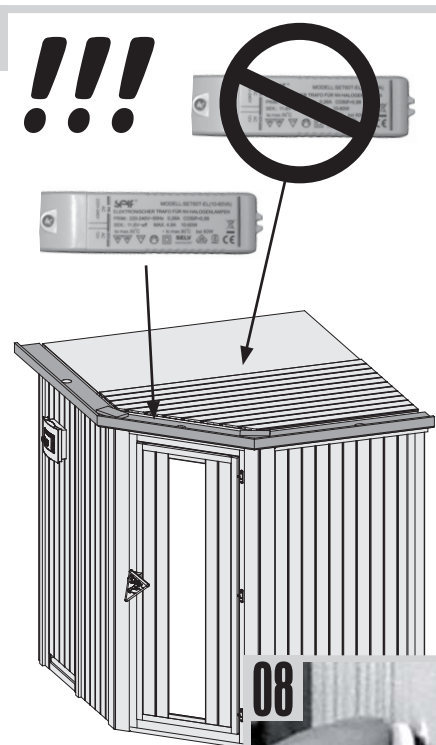

08

